

Metro

*Los Angeles County Metropolitan Transportation Authority
One Gateway Plaza
3rd Floor Board Room*



Agenda - Final

Thursday, March 21, 2019

10:15 AM

**One Gateway Plaza, Los Angeles, CA 90012,
3rd Floor, Metro Board Room**

Construction Committee

Robert Garcia, Chair

Jacquelyn Dupont-Walker, Vice Chair

Kathryn Barger

Janice Hahn

James Butts

John Bulinski, non-voting member

Phillip A. Washington, Chief Executive Officer

METROPOLITAN TRANSPORTATION AUTHORITY BOARD RULES
(ALSO APPLIES TO BOARD COMMITTEES)

PUBLIC INPUT

A member of the public may address the Board on agenda items, before or during the Board or Committee's consideration of the item for one (1) minute per item, or at the discretion of the Chair. A request to address the Board should be submitted in person at the meeting to the Board Secretary. Individuals requesting to speak on more than three (3) agenda items will be allowed to speak up to a maximum of three (3) minutes per meeting. For individuals requiring translation service, time allowed will be doubled.

Notwithstanding the foregoing, and in accordance with the Brown Act, this agenda does not provide an opportunity for members of the public to address the Board on any Consent Calendar agenda item that has already been considered by a Committee, composed exclusively of members of the Board, at a public meeting wherein all interested members of the public were afforded the opportunity to address the Committee on the item, before or during the Committee's consideration of the item, and which has not been substantially changed since the Committee heard the item.

The public may also address the Board on non-agenda items within the subject matter jurisdiction of the Board during the public comment period, which will be held at the beginning and/or end of each meeting. Each person will be allowed to speak for up to three (3) minutes per meeting and may speak no more than once during the Public Comment period. Speakers will be called according to the order in which the speaker request forms are received. Elected officials, not their staff or deputies, may be called out of order and prior to the Board's consideration of the relevant item.

In accordance with State Law (Brown Act), all matters to be acted on by the MTA Board must be posted at least 72 hours prior to the Board meeting. In case of emergency, or when a subject matter arises subsequent to the posting of the agenda, upon making certain findings, the Board may act on an item that is not on the posted agenda.

CONDUCT IN THE BOARD ROOM - The following rules pertain to conduct at Metropolitan Transportation Authority meetings:

REMOVAL FROM THE BOARD ROOM The Chair shall order removed from the Board Room any person who commits the following acts with respect to any meeting of the MTA Board:

- a. Disorderly behavior toward the Board or any member of the staff thereof, tending to interrupt the due and orderly course of said meeting.
- b. A breach of the peace, boisterous conduct or violent disturbance, tending to interrupt the due and orderly course of said meeting.
- c. Disobedience of any lawful order of the Chair, which shall include an order to be seated or to refrain from addressing the Board; and
- d. Any other unlawful interference with the due and orderly course of said meeting.

INFORMATION RELATING TO AGENDAS AND ACTIONS OF THE BOARD

Agendas for the Regular MTA Board meetings are prepared by the Board Secretary and are available prior to the meeting in the MTA Records Management Department and on the Internet. Every meeting of the MTA Board of Directors is recorded on CD's and as MP3's and can be made available for a nominal charge.

DISCLOSURE OF CONTRIBUTIONS

The State Political Reform Act (Government Code Section 84308) requires that a party to a proceeding before an agency involving a license, permit, or other entitlement for use, including all contracts (other than competitively bid, labor, or personal employment contracts), shall disclose on the record of the proceeding any contributions in an amount of more than \$250 made within the preceding 12 months by the party, or his or her agent, to any officer of the agency, additionally PUC Code Sec. 130051.20 requires that no member accept a contribution of over ten dollars (\$10) in value or amount from a construction company, engineering firm, consultant, legal firm, or any company, vendor, or business entity that has contracted with the authority in the preceding four years. Persons required to make this disclosure shall do so by filling out a "Disclosure of Contribution" form which is available at the LACMTA Board and Committee Meetings. Failure to comply with this requirement may result in the assessment of civil or criminal penalties.

ADA REQUIREMENTS

Upon request, sign language interpretation, materials in alternative formats and other accommodations are available to the public for MTA-sponsored meetings and events. All requests for reasonable accommodations must be made at least three working days (72 hours) in advance of the scheduled meeting date. Please telephone (213) 922-4600 between 8 a.m. and 5 p.m., Monday through Friday. Our TDD line is (800) 252-9040.

LIMITED ENGLISH PROFICIENCY

A Spanish language interpreter is available at all Committee and Board Meetings. All other languages must be requested 72 hours in advance of the meeting by calling (213) 922-4600 or (323) 466-3876.



323.466.3876 x2

Español

323.466.3876 x3

한국어

日本語

中文

русский

ភាសាខ្មែរ

ภาษาไทย

Tiếng Việt

ភាសាជប៉ុន

HELPFUL PHONE NUMBERS

Copies of Agendas/Record of Board Action/Recordings of Meetings - (213) 922-4880 (Records Management Department)

General Information/Rules of the Board - (213) 922-4600

Internet Access to Agendas - www.metro.net

TDD line (800) 252-9040

NOTE: ACTION MAY BE TAKEN ON ANY ITEM IDENTIFIED ON THE AGENDA

CALL TO ORDER**ROLL CALL****APPROVE Consent Calendar Item(s): 26.****Consent calendar items are approved by one motion unless held by a Director for discussion and/or separate action.**CONSENT CALENDAR**26. SUBJECT: QUALITY MANAGEMENT CONSULTANT** [2019-0054](#)**RECOMMENDATION**

AUTHORIZE the Chief Executive Officer (CEO) to:

- A. AWARD AND EXECUTE a seven (7) year cost reimbursable, Contract No. PS54007, to PQM, Inc., for Quality Management Consultant Program Services on Task Orders for an amount not-to-exceed \$5,378,518 for an initial twenty-six months; plus three one year options, subject to resolution of any properly submitted protest; and
- B. EXECUTE individual Task Orders and changes within the Board approved contract not-to-exceed amount.

Attachments: [Attachment A - Procurement Summary](#)
 [Attachment B - DEOD Summary \(2019-0054\)](#)

NON-CONSENT**27. SUBJECT: PROGRAM MANAGEMENT MAJOR PROJECT STATUS REPORT** [2019-0069](#)**RECOMMENDATION**

RECEIVE oral report on the Major Project Status by the Chief Program Management Officer.

Attachments: [Attachment A - Program Management Major Project Status Report - March 2019](#)

28. SUBJECT: PROJECT LABOR AGREEMENT/CONSTRUCTION CAREERS POLICY (PLA/CCP) [2019-0032](#)**RECOMMENDATION**

RECEIVE AND FILE the:

- A. Status update on the Project Labor Agreement and Construction Careers

Policy programs through the quarter ending December 2018; and

B. Women in the Trades Action Plan.

Attachments: [Attachment A - PLA CCP Completed Projects](#)
[Attachment B - PLA CCP Report Data](#)
[Attachment C - Contractors Action Plan to Increase Female Participation Presentation](#)

(ALSO ON EXECUTIVE MANAGEMENT COMMITTEE)

32. SUBJECT: METRO GOLD LINE INTERSTATE 210 BARRIER REPLACEMENT [2019-0119](#)

RECOMMENDATION

CONSIDER:

- A. INCREASING Design Life-of-Project (LOP) Budget for Metro Gold Line Interstate 210 Barrier Replacement, (CP Number 405581) by \$11,463,026, increasing the LOP budget from \$11,078,366 to \$22,541,392; and
- B. AUTHORIZING the Chief Executive Officer to execute Contract Modification No. 1 to the On-Call Highway Program Project Delivery Support Services Contract Nos. AE30673000, AE30673001, AE30673002 with AECOM, CH2M Hill, and Parsons Transportation Group, respectively, in the amount not-to exceed \$11,000,000 increasing the total contract value from \$30,000,000 to \$41,000,000.

Attachments: [Attachment A - Procurement Summary](#)
[Attachment B - Contract Modification Change Order Log](#)
[Attachment C - DEOD Summary](#)
[Attachment D - Funding Expenditure Plan](#)

SUBJECT: GENERAL PUBLIC COMMENT [2019-0134](#)

RECEIVE General Public Comment

Consideration of items not on the posted agenda, including: items to be presented and (if requested) referred to staff; items to be placed on the agenda for action at a future meeting of the Committee or Board; and/or items requiring immediate action because of an emergency situation or where the need to take immediate action came to the attention of the Committee subsequent to the posting of the agenda.

COMMENTS FROM THE PUBLIC ON ITEMS OF PUBLIC INTEREST WITHIN COMMITTEE'S SUBJECT MATTER JURISDICTION

Adjournment



Board Report

File #: 2019-0054, File Type: Contract

Agenda Number: 26.

CONSTRUCTION COMMITTEE MARCH 21, 2019

SUBJECT: QUALITY MANAGEMENT CONSULTANT

ACTION: AWARD PROFESSIONAL SERVICES CONTRACT

RECOMMENDATION

AUTHORIZE the Chief Executive Officer (CEO) to:

- A. AWARD AND EXECUTE a seven (7) year cost reimbursable, Contract No. PS54007, to PQM, Inc., for Quality Management Consultant Program Services on Task Orders for an amount not-to-exceed \$5,378,518 for an initial twenty-six months; plus three one year options, subject to resolution of any properly submitted protest; and
- B. EXECUTE individual Task Orders and changes within the Board approved contract not-to-exceed amount.

ISSUE

Staff seeks to award a Quality Management Consultant Program Services contract to assist Metro in the delivery of voter approved Measures R, M, and other Board approved Capital Improvement projects. The recommended action will provide contract authority for Task Orders issued during the initial 26 months, FY's 2019, 2020, and 2021. Staff intends to return to the Board in two years to request additional contract authorization as additional contracts develop and the new quality oversight program matures.

BACKGROUND

The delivery of quality capital projects is a major goal of Metro's Program Management Department and a commitment made to the public and the Metro Board. As the size and complexity of Metro's capital program grows, it is important to have the systematic quality assurance tools and capabilities to keep up with this program.

The ability of the Quality Division to support the Measures R & M projects with a Quality Management Oversight (QMO) System depends on procuring consultant services to upgrade and improve our present system. The enhancements will assist and support staff in the oversight and verification of Contractor's compliance to the projects' requirements.

DISCUSSION

Metro's Quality Management Program requires utilization of Consultant services to develop, implement, and manage a Quality Management Oversight System. Training of employees and other personnel affected by this QMO System will also be needed as well as development of supporting tools. The Purple Line Extensions 2 & 3 have been selected as the first projects to implement this system. In addition, this QMO system will be applied to all other major capital improvement projects once the program has been proven effective.

Term

Due to the length of time needed to deliver major capital improvement projects, it is inefficient and disruptive to change the contractor during project delivery. The recommended Quality Management Consultant term will provide Quality Management Oversight Support Services with greater continuity, consistency, and less disruption by implementing a base seven (7) year contract with three (3) one-year options.

Scope

The scope of services to be provided by the Consultant includes, but is not limited to: development and implementation of an ISO 9001:2015, Quality Management System; development and implementation of an QMO Training Program; manage Project Database Requirements; internal quality audits of Project Management processes; trend analysis and feedback; Materials Verification Testing & Inspection program (OVT) Database tool; support for Project Close-Out and acceptance; implement Quality Improvement Methodologies for overall program and project continuous improvement.

The primary purpose of this contract is to establish an improved QMO system for Metro. The Services to be performed will include provision of a QMO Program Manual that meets the requirements of ISO 9001:2015. Services will also provide a requirements database tools for requirements management, data analysis, reporting, and product acceptance. The scope of services also includes supporting Metro to achieve certification to the ISO 9001:2015 standard and facilitate the ISO Registrar to perform a registration audit and subsequent annual surveillance audits. The benefits of this QMO enhancement include improvements in:

- Confidence and accountability to project stake holders.
- Communications to project participants.
- Productivity of staff resources.
- Delivery and quality of contract requirements.

DETERMINATION OF SAFETY IMPACT

The Board action will not have any adverse safety impacts on Metro's Construction projects, Operations, our employees, and/or patrons.

FINANCIAL IMPACT

The FY19 Budget includes \$1,600,000 for this recommendation under Project 100055 (Measure R Overhead), Cost Center 8110 (Quality Assurance/Compliance) and Account 50316 (Professional Services). The FY19 budget is planned for support of the program wide elements of the contract which cannot be assigned or funded by a specific project.

Since this is a task order driven contract defined by detailed scope(s) of work, each task order (TO) shall be charged to a Measure R/M (MR/MM) project, State of Good Repair (SGR) project or MR/MM Overhead project for the program wide quality elements and activities. The funds for the assigned TO (s) will be included as part of the respective MR/MM project or SGR life of project (LOP) funds to fund the assigned scope of work described in the task orders.

Staff anticipates the overhead nature of the workscope to occur from the remainder of FY19 thru FY21. This time frame will initially require a not to exceed amount of \$3,000,000 to be funded under Project 100055. Annual overhead allotments beyond FY21 are expected to decrease by more than 50% as new quality oversight program task orders will be applied directly to respective projects and as the ISO 9001:2015 certification is achieved. Beyond FY21, future overhead related task orders will be required for maintaining the certification and the continuous improvement of the quality program.

Upon approval of the recommendation, staff shall return to the Board every two years to provide a status update and, if required, request additional contract authorization as the new program matures in order to accurately estimate the anticipated level of required resources. Since this is a multi-year project, the Project Manager and Chief Program Management Officer will be responsible for budgeting in future fiscal years.

Impact to Budget

Upon approval of this action, up to \$400,000 of the \$1,600,000 in the FY19 budget under Project 100055 (MR Overhead) will be used to initiate the program wide support efforts. Any additional funding for TOs issued under this action will be provided by the specific project benefiting the services.

The source funds for project 100055 are Measure R Admin funds. Task orders assigned to MR/MM Projects will be funded within the LOP funding plans of the respective project(s). The project funds may consist of federal and/or state grants, local funds and loans. Many state-of-good-repair and capital improvement projects are funded with local funding sources which are eligible for rail and bus operations.

IMPLEMENTATION OF STRATEGIC PLAN GOALS

Executing Contract, No.PS54007 would permit Metro's Program Management/Quality Department to provide an efficient, consistent and high level of support to Measures R, M projects; therefore, it would positively support Metro's overall plan and goal of expanding the transportation network, increase mobility for all users and improve LA County's overall transit network and assets.

ALTERNATIVES CONSIDERED

The Board may reject the recommendation, proposed duration, or initial funding authorization. Staff does not recommend these alternatives. The use of a consultant allows the agency to secure highly technical expertise without the necessary increase in Metro long term labor costs. Further, by providing for an overall term of seven years plus three one-year options, an integrated and consistent approach across all projects serves Metro's interests. Finally, by limiting funding to two years, greater accuracy of project scope and cost requirements can be provided to the Board on a two-year basis.

NEXT STEPS

Upon Board approval, staff will complete the process to award and execute the contract. Specific task orders will be subsequently issued on an as needed basis.

ATTACHMENTS

Attachment A - Procurement Summary

Attachment B - DEOD Summary

Prepared by: Herman Gallardo, Sr. Quality Assurance Manager (213-922-1386)

Camelia Davis, Sr Director Quality Management (213) 922- 7342

Reviewed by: Richard Clarke, Chief Program Management Officer (213) 922-7557

Debra Avila, Chief Vendor/Contract Management Officer (213) 418-3051

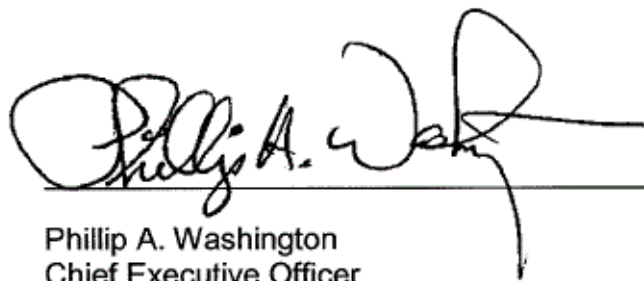

Phillip A. Washington
Chief Executive Officer

PROCUREMENT SUMMARY

QUALITY MANAGEMENT CONSULTANT (QMC)
PS54007

1.	Contract Number: PS54007	
2.	Recommended Vendor: PQM, Inc.	
3.	Type of Procurement (check one): <input type="checkbox"/> IFB <input checked="" type="checkbox"/> RFP <input type="checkbox"/> RFP-A&E <input type="checkbox"/> Non-Competitive <input type="checkbox"/> Modification <input type="checkbox"/> Task Order	
4.	Procurement Dates:	
	A. Issued: September 21, 2018	
	B. Advertised/Publicized: September 22, 2018	
	C. Pre-Proposal Conference: October 3, 2018	
	D. Proposals Due: November 6, 2018	
	E. Pre-Qualification Completed: 01/30/2019	
	F. Organizational Conflict of Interest Review Completed by Ethics: 12/5/18	
	G. Protest Period End Date: March 21, 2019	
5.	Solicitations Picked up/Downloaded: 130	Proposals Received: 6
6.	Contract Administrator: Rafael Vasquez	Telephone Number: 213.418-3036
7.	Project Manager: Herman Gallardo	Telephone Number: 213.922-1385

A. Procurement Background

This Board action is to approve Contract No. PS54007 Quality Management Consultant Program Services (QMC), to supplement Metro's Program Management's Office of Quality Management in providing the following services: Development of an ISO 9001:2015 Quality Management Systems-Requirements Compliant Quality Management Oversight (QMO) Program, Management of Project Database Requirements, Implementation of the QMO Program, Internal Quality Audit of Project Management Process, Trend Analysis and Feedback, Deployment of Owner's Verification Testing (OVT) Database Tool, Support for Project Closeout and Acceptance, and Implementation of Quality Improvement Methodologies for Overall Program and Project Continuous Improvement. The QMC will furnish all labor, material, and other related items required to perform the services on a contract Work Order basis under specific Task Order and Period of Performance. Board approval of contract awards are subject to resolution of any properly submitted protest.

The Request for Proposals (RFP) was a competitively negotiated based procurement process, performed in accordance with Metro Procurement Policies and Procedures. This process required each of the responding firms' qualifications to be evaluated on the technical requirements and approaches as described in the Scope of Services. The weightings for the technical factors and the cost proposal were included in the RFP. The proposing firms were rated accordingly and the results are below as shown. The RFP was issued with a DBE goal of 22%. The contract type is a cost plus fixed fee. The Contract is for a term of seven (7) years with three (3) one-year options.

Two amendments were issued during the solicitation phase of the RFP:

- Amendment No. 1, issued on October 8, 2018, extended the proposals due date from October 23, 2018 to November 6, 2018.
- Amendment No. 2, issued on October 12, 2018, clarified Form 60 where the positions listed in the Cost of Pricing Summary were required for evaluation purposes.

A total of six (6) proposals were received on November 6, 2018, from the following firms:

- ABA Global, Inc.
- Alta Vista Solutions
- ATSER LP
- MARRS Services, Inc.
- PQM, Inc.
- Trident CPM Consulting

B. Evaluation of Proposals

A Proposal Evaluation Team (PET) consisting of staff from Metro Program Management Capital Improvements Projects, Office of Quality Management, and Safety, Risk & Asset Department was convened and conducted a comprehensive evaluation of the proposals received.

The proposals were evaluated based on the following evaluation criteria and the associated weightings:

- | | |
|---|------------|
| • Experience and Capabilities of the Firms on the Consultant's Project Team | 25 percent |
| • Key Personnel's Skills and Experience | 20 percent |
| • Effectiveness of Management Plan | 20 percent |
| • Understanding of Work and Appropriateness of Approach for Implementation | 25 percent |
| • Cost Proposal | 10 percent |

The evaluation criteria were appropriate and consistent with criteria developed for other, similar Professional Service procurements. Several factors were considered when developing the weightings, giving the greatest importance to the Experience and Capabilities of the Firms on the Consultant's Project Team, and Understanding of Work and Appropriateness of Approach for Implementation.

The PET evaluated the six (6) written qualification proposals from November 2018 through early December 2018. Of the six (6) proposals received, four (4) were determined to be within the competitive range. The four firms are listed below in alphabetical order:

1. Alta Vista Solutions
2. ATSER LP
3. MARRS Services, Inc.
4. PQM, Inc.

ABA Global, Inc. and Trident CPM Consulting proposals were considered to be outside the competitive range and excluded from further consideration. Both proposers were notified of the determination.

On December 11 and 12, 2018, the PET met with the four (4) Proposers for oral presentations. The firms were given the opportunity to present on: 1) Experience and Capabilities of the Firms on the Consultant's Project Team and 2) Understanding of Work and Appropriateness of Approach for Implementation.

The proposing firms had the opportunity to present their proposed project managers, key personnel and some of their key members, as well as respond to the PET's questions. In general, each Proposer's presentation addressed the requirements of the RFP, experience with all aspects of the required and anticipated tasks, and stressed each proposer's commitment to the success of the contract.

Qualifications Summary of Firms within the Competitive Range:

PQM, INC.

- PQM's proposal significantly exceeds the RFP minimum requirements in the experience and capabilities of the firms on the consultant team criteria. The PQM team has proven outstanding experience implementing similar services as the QMO program.
- PQM's proposal significantly exceeds the RFP minimum requirements in the key personnel's skill and experience criteria. The proposed Program Manager and Program Director have over 20 years of experience in quality management and several ASQ quality related certifications and systems engineering.
- The proposed QMC Program Manager is highly qualified, and experience in transit QMO programs and ISO 9001 compliance.
- PQM's proposed organization and approach indicates an exceptional understanding of the QMC goals, staffing needs and exceeded the DBE goal requirements.
- The PQM team is specially structured to integrate with Metro staff, clear roles, focused on training, productivity, and plan for managing conflicts.

ATSER LP

- The proposal substantially meets the RFP minimum requirements in the Experience and Capabilities of the Firms on the Consultant's Project Team criteria.
- The prime proposer has very good experience in quality management services and the proposed QMS software **Assure-IT™** has been developed and used for 25 years.
- The proposal significantly meets the RFP minimum requirements in the Key Personnel's Skills and Experience. The proposed team has very good experience with this type of scope in the transportation area. The proposal demonstrated highly experienced key personnel in QMO work on behalf of agencies or large projects.
- The proposal substantially meets the RFP minimum experience requirements in interfacing with third parties such as cities, FTA, and Caltrans.
- The proposal demonstrated satisfactory experience and performance in regards to past experience with cost, quality and auditing.
- The proposed organization and approach indicates a very good understanding of the QMC /QMO staffing needs and goals.
- The proposer has a very good understanding of the major challenges and how to address them.

ALTA VISTA SOLUTIONS

- The proposal generally meets the RFP minimum requirements. The proposed approach indicates an adequate and sound understanding of the project goals and methods and other aspects essential to the performance of the project.
- The proposal provided a very good vision in regards to the integration of the QMO program with Metro Quality Assurance staff.
- The Proposer assembled a good team with a depth of sub-consulting team members experienced in a program of this magnitude, and firms dedicated to QMO.
- The Proposer's key personnel team members generally meet the RFP minimum experience requirements. The proposed QMC Program Manager has experience with agencies and programs similar to the Metro Capital programs.
- The proposal demonstrated a strong and well thought-out organization of team members, and co-locating of firm partners. The Proposer and team member firms demonstrated very good capacity to take on assignments.
- The Proposer's PM and key personnel demonstrated very good experience in development of a QMO program.
- The audit and performance lead staff possesses the required ASQ CMQ/OE certification and have experience in quality management programs and its elements.
- The Proposer has a very good understanding of integration with Metro team and staff.

MARRS SERVICES, INC.

- The proposal generally meets the RFP minimum requirements in the Experience and Capabilities of the Firms on the Consultant’s Project Team. The Proposer and other sub-consultant team members demonstrated excellent knowledge and experience working with other public transit agencies and other agencies (cities and counties) and would be able to interface with affected stakeholders for purposes of interagency coordination.
- The proposal substantially meets the RFP minimum requirements in the Key Personnel’s Skill and Experience criteria. The proposed approach indicates a thorough understanding of the project needs, challenges and goals.
- The proposal’s approach to develop and integrate a QMO program is described well and is sound, including the major steps that will be undertaken by the team; all are in accordance with the Scope of Services.

The PET ranked the four (4) proposals in the competitive range, based on the evaluation criteria in the RFP, and assessed major strengths, weaknesses and associated risks of each of the Proposers to determine the most advantageous firm. The final scoring was based on evaluation of the written proposals, as supported by oral presentations, and clarifications received from the Proposers. The results of the final scoring are shown below:

	Firm	Average Score**	Factor Weight	Weighted Average Score*	Rank
1	PQM, Inc				
2	Experience and Capabilities of the Firms on the Consultant’s Project Team	94.93	25%	23.73	
3	Key Personnel’s Skills and Experience	95.67	20%	19.13	
4	Effectiveness of Management Plan	94.00	20%	18.80	
5	Understanding of Work and Appropriateness of Approach for Implementation	95.33	25%	23.83	
6	Cost Proposal	84.20	10%	8.42	
7	Total		100.00%	93.91	1
8	ATSER LP				
90	Experience and Capabilities of the Firms on the Consultant’s Project Team	84.00	25%	21.00	
10	Key Personnel’s Skills and Experience	87.50	20%	17.50	
11	Effectiveness of Management	84.08	20%	16.82	

	Plan				
12	Understanding of Work and Appropriateness of Approach for Implementation	88.13	25%	22.03	
13	Cost Proposal	100.00	10%	10.00	
14	Total		100.00%	87.35	2
15	ALTA VISTA SOLUTIONS				
16	Experience and Capabilities of the Firms on the Consultant's Project Team	79.53	25%	19.88	
17	Key Personnel's Skills and Experience	77.58	20%	15.52	
18	Effectiveness of Management Plan	80.50	20%	16.10	
190	Understanding of Work and Appropriateness of Approach for Implementation	78.93	25%	19.73	
20	Cost Proposal	97.20	10%	9.72	
21	Total		100.00%	80.95	3
22	MARRS SERVICES, INC.				
23	Experience and Capabilities of the Firms on the Consultant's Project Team	71.07	25%	17.77	
24	Key Personnel's Skills and Experience	81.17	20%	16.23	
25	Effectiveness of Management Plan	78.92	20%	15.78	
26	Understanding of Work and Appropriateness of Approach for Implementation	83.53	25%	20.88	
27	Cost Proposal	95.80	10%	9.58	
28	Total		100.00%	80.24	4

* Weighted Scores are rounded up to the nearest second decimal point.

** Cost proposals were based on the Proposer's rates for a sample level of effort of 7,500 hours only. Scores shown above for the cost proposals are based on formulae in the RFP highest score going to the lowest cost proposal.

C. Cost/Price Analysis

Metro performed a cost analysis of labor rates and comparing the four (4) proposals in the competitive range with one another as well as Metro's estimate. All proposals were based on direct labor rates, overhead rates, other direct costs, sub-consultant rates, and fixed fee, and the impact is reflected in the cost score above. The

proposed labor rates, indirect rates and other direct costs for the recommended firm were determined to be fair and reasonable.

	Proposer Name	Proposal Amount ⁽¹⁾	Metro ICE ⁽²⁾	Recommended NTE Amount ⁽³⁾
1	PQM, Inc.	\$1,691,693	\$5,378,518	\$5,378,518
2	ATSER LP	\$1,423,628		
3	Alta Vista Solutions	\$1,464,427		
3	MARRS Services, Inc.	\$1,486,260		

Notes:

- (1) The proposal amounts shown were for evaluation purposes only and were based on the rates for a sample level of effort (7500 hours, only) since there was no definable total level of effort for the Scope of Services. Hourly labor rates, overhead and fee were negotiated and determined to be fair and reasonable.
- (2) The amount \$5,378,518 is a Not-to-Exceed amount estimated for the first 26 months (May – June FY’19, FY’20 and FY’21) of the contract.
- (3) The amount \$5,378,518 is a Not-to-Exceed amount for the first 26 months (May – June FY’19, FY’20 and FY’ 21) of the contract. Future work will be funded according to an Annual Work Program, on a two year basis. The total contract amount will be the aggregate value of all task orders negotiated with the Consultant through the term of the contract.

D. Background on Recommended Contractor

The recommended firm, PQM, Inc., is LOCATED IN Huntington Beach, CA; it is a certified DBE, SBE and WBE firm and is the prime consultant of the team. Founded in 2006, PQM is a quality management consulting firm focused on improving project delivery through the development and implementation of effective quality management programs. PQM specializes in developing, implementing and monitoring ISO 9001 compliant quality management programs for major capital improvement programs.

DEOD SUMMARY

QUALITY MANAGEMENT CONSULTANT (QMC) / PS54007

A. Small Business Participation

The Diversity and Economic Opportunity Department (DEOD) established a 22% Disadvantaged Business Enterprise (DBE) goal for this Task Order Contract. PQM, Inc. (a DBE Prime) made a 32% DBE commitment for this Task Order Contract.

In response to a specific Task Order request with a defined scope of work, the prime contractor will be required to identify DBE subcontractor activity and actual dollar value commitments for that Task Order. Overall DBE achievement in meeting the commitment will be determined based on the cumulative DBE participation of all Task Orders awarded.

Metro Project Managers and Contract Administrators will work in conjunction with DEOD to ensure that PQM, Inc is on schedule to meet or exceed its DBE commitments. Accordingly, access has been provided to Metro’s tracking and monitoring system to key stakeholders over the contract to ensure that all parties are actively tracking Small Business progress.

Small Business Goal	DBE 22%	Small Business Commitment	DBE 32%
----------------------------	----------------	----------------------------------	----------------

	DBE Prime/Subcontractors	Ethnicity	% Committed
1.	PQM, Inc. (PRIME)	Non-Minority Female	TBD
2.	System Consulting, LLC	African American	TBD
3.	NSI Engineering, Inc.	Non-Minority Female	TBD
	Total DBE Commitment		32%

B. Living Wage and Service Contract Worker Retention Policy Applicability

The Living Wage and Service Contract Worker Retention Policy is not applicable to this contract.

C. Prevailing Wage Applicability

Prevailing wage is not applicable to this contract.

D. All Subcontractors Included with Recommended Contractor’s Proposal

	Subcontractor	Services Provided
1.	Parsons Transportation Corp., Inc.	Quality Management Consulting
2.	Systems Consulting LLC	QMO Support
3.	NSI Engineering, Inc.	Quality Management Consulting

E. Project Labor Agreement/Construction Careers Policy

Project Labor Agreement/Construction Careers Policy is not applicable to this Contract. Project Labor Agreement/Construction Careers Policy is applicable only to construction contracts that have a construction contract value in excess of \$2.5 million.



Board Report

File #: 2019-0069, **File Type:** Oral Report / Presentation

Agenda Number: 27.

CONSTRUCTION COMMITTEE MARCH 21, 2019

SUBJECT: PROGRAM MANAGEMENT MAJOR PROJECT STATUS REPORT

ACTION: ORAL REPORT

RECOMMENDATION

RECEIVE oral report on the Major Project Status by the Chief Program Management Officer.

DISCUSSION

Update report covering the month of March 2019 by the Chief Program Management Officer.

ATTACHMENTS

Attachment A - Program Management Major Project Status Report

Prepared by:

- **Crenshaw/LAX** - Sameh Ghaly, Sr EO Project Mgmt., (213) 418-3369
- **Regional Connector** - Gary Baker, EO Project Mgmt., (213) 893-7191
- **Westside Purple Line Ext 1** - James Cohen, EO Project Mgmt., (213) 922-7911
- **Westside Purple Line Ext 2** - Michael McKenna, EO Project Mgmt., (213) 312-3132
- **Westside Purple Line Ext 3** - Kimberly Ong, EO Project Mgmt., (323) 903-4112
- **Patsaouras Plaza Busway Station** - Timothy Lindholm, EO Project Engr., (213) 922-7297
- **Willowbrook/Rosa Park Station** - Timothy Lindholm, EO Project Engr., (213) 922-7297
- **The New Blue** - Timothy Lindholm, EO Project Engr., (213) 922-7297
- **I-210 Barrier Replacement** - Androush Danielians, EO Project Engr., (213) 922-7598
- **I-5 North** - Abdollah Ansari, Sr EO Construction & Engr., (213) 922-4781
- **I-5 South** - Abdollah Ansari, Sr EO Construction & Engr., (213) 922-4781
- **Presentation** - Shannon Hanley, Chief Administrative Analyst, (213) 922-1350

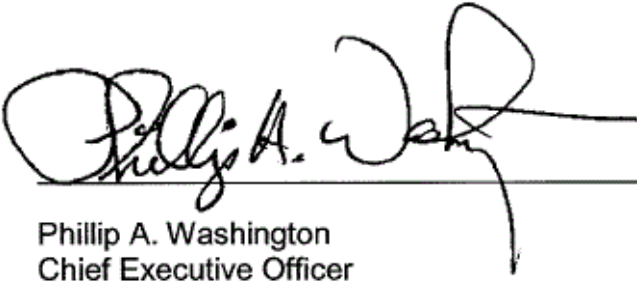

Phillip A. Washington
Chief Executive Officer

Program Management Major Project Status Report

Presented By

Richard Clarke

Chief Program Management Officer

March 2019

Construction Committee

Los Angeles County Metropolitan Transportation Authority



PROJECT BUDGET & SCHEDULE STATUS SUMMARY CHART

Project	Cost Performance	Schedule Performance	Comments
Crenshaw/LAX			Project is 91% complete. Metro issued non-compensable time extension to contractor extending Contract Substantial Completion Milestone to December 2019. The forecast revenue service date is Spring 2020.
Regional Connector			Project is 56% complete and proceeding on schedule and within budget.
Westside Purple Line Extension-Section 1			Project is 45% complete and proceeding on schedule and within budget.
Westside Purple Line Extension-Section 2			Project is 15% complete and proceeding on schedule and within budget.
Westside Purple Line Extension-Section 3			Issued Notice to Proceed (NTP) to Frontier-Kemper/Tutor Perini, a Joint Venture for the C1151 Tunnels Contract on January 15, 2019.
Patsaouras Plaza			Project is approximately 65% complete. Metro issued Order of Suspension August 3rd due to archaeological and Native American issues. With anticipated construction delay of 11 months, significant impacts to project schedule and budget expected. Project expected to resume construction by late March 2019.
Willowbrook/Rosa Parks Station			Package A is 20% complete with structural and framing work continuing on the Customer Service and Mobility Hub Buildings. Blue Line Station and Mezzanine work initiated with closure of Blue Line. Package B 100% bid package being finalized.
Metro Blue Line Projects			Major construction started January 26, 2019 with shut down of Metro Blue Line south segment. All construction work is proceeding per schedule and inclement weather mitigations are in place as necessary.
I-210 Barrier Replacement			Finding effective mitigation measures to some of the non-standard freeway features along with mitigation measures to alleviate freeway traffic disruption during construction are delaying the project.
I-5 North: SR 118 to SR 134			Segment 1 & 2 (SR 118 to Buena Vista) are complete and open to traffic. Segment 3 (Empire) is 72% complete. Segment 4 (Magnolia to SR-134) is 89% complete.
I-5 South: Orange County Line to I-605			Segment 2 (Valley View) is 38% complete. Segment 3 (Rosecrans) is open to traffic. Segment 4 (Imperial) is 94% complete. Segment 5 (Florence) is 76% complete.

March 2019



On target



Possible problem



Major issue



Metro 2

Construction Committee

Los Angeles County Metropolitan Transportation Authority

CRENSHAW/LAX TRANSIT PROJECT

⚠️ BUDGET		
	<u>Current</u>	<u>Forecast</u>
TOTAL COST	\$2,058M	\$2,058M

⚠️ SCHEDULE		
	<u>Current</u>	<u>Forecast</u>
REVENUE	Fall	Spring
OPERATION	2019	2020

- Overall Project Progress is 91% complete; addressing contractor construction schedule
- Contractor continues critical construction efforts in the north end underground structures
- Working with 3rd parties to complete power drops for traction power substations in support of testing systems equipment
- Working on completing grade crossing in the south end to support start of Phase 1 systems testing integration in spring
- Contractor addressing open sidewalk, street punch list items



Plaza level walls at Martin Luther King Jr. Station



Substantial Completion achieved at Division 16

March 2019



On target



Possible problem



Major issue

Construction Committee

Los Angeles County Metropolitan Transportation Authority



Metro 3

REGIONAL CONNECTOR TRANSIT PROJECT

OK BUDGET

	<u>Current</u>	<u>Forecast</u>
TOTAL COST	\$1,810M	\$1,810M

OK SCHEDULE

	<u>Current</u>	<u>Forecast</u>
	Spring/Summer	Spring/Summer
	2022	2022
REVENUE		
OPERATION		

- Overall Project Progress is 56% complete
- Underground:** SEM crossover cavern excavation complete; final liner and plenum work has commenced
- Little Tokyo/Arts District Station, WYE and 1st Street:** Excavation and related support of utilities continue at WYE and 1st Street; structural concrete operations underway on station box walls
- Historic Broadway Station:** Structural concrete continues with exterior walls in station box and entrance concourse
- Grand Av Arts/Bunker Hill Station:** Structural concrete walls continue to be erected at multiple levels throughout station
- Flower Street:** Excavation and utility protection south of 5th continues

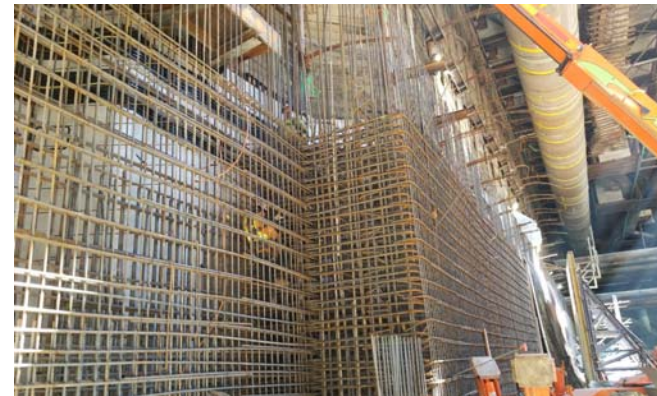

Rebar installation on Wall B of Historic Broadway Station



View from inside SEM Cavern to station

March 2019



On target



Possible problem



Major issue

Construction Committee

Los Angeles County Metropolitan Transportation Authority



Metro 4

WESTSIDE PURPLE LINE EXTENSION – SECTION 1

OK BUDGET		
	<u>Current</u>	<u>Forecast</u>
TOTAL COST*	\$3,154M	\$3,154M

* Includes Board approved LOP budget plus finance costs.

OK SCHEDULE		
	<u>Current</u>	<u>Forecast</u>
REVENUE OPERATION	Fall 2024 (FFGA)	Fall 2023

- Overall Project Progress is 45% complete.
- Wilshire/Western Retrieval Shaft:** In January 2019, the Tunnel Boring Machine (TBM) temporary support slab was placed, and all lanes were re-opened on Wilshire Boulevard. Waler and strut removal is underway.
- Wilshire/La Brea Station:** Concrete placement for interior load bearing walls continues. Shoring and decking installation for the concourse deck is on-going.
- Wilshire/Fairfax Station:** Mass excavation at the east end of the station continues. On-going activities: fine grading of sub-grade; grounding grid, vent mat, gravel layer installation.
- Wilshire/La Cienega Station:** Installation of Level C struts continues. Bottom of excavation is anticipated to be reached in May 2019.
- Reach 1 TBM Progress (W/LB to W/W):** TBM #1 - 3,742 ft. or 39%; TBM #2 – 2,812 ft. or 29% as of February 13, 2019.



Reconfiguration of Ventilation at the Western Shaft



Reach 1 Tunneling

March 2019

Construction Committee

Los Angeles County Metropolitan Transportation Authority



On target



Possible problem



Major issue



Metro 5

WESTSIDE PURPLE LINE EXTENSION – SECTION 2

OK BUDGET		
	<u>Current</u>	<u>Forecast</u>
TOTAL COST*	\$2,530M	\$2,530M

* Includes Board approved LOP budget plus finance costs.

OK SCHEDULE		
	<u>Current</u>	<u>Forecast</u>
REVENUE OPERATION	Winter 2026 (FFGA)	Summer 2025

- Overall project progress is 15% complete.
- Final design progress is 90% complete.
- **Century City Constellation**
 - Cable pulling and splicing for LADWP Power and AT&T is ongoing with an anticipated completion date of November 2019.
 - Soldier pile installation at the tunnel boring machine (TBM) launch box was completed in January 2019.
 - Santa Monica bus layover construction is ongoing with an anticipated completion in March 2019.
 - AT&T parking structure demolition started in December 2018 and is ongoing. The anticipated turnover of the property to Metro is March 2019.
- **Wilshire/Rodeo**
 - Preparation for wet utility relocations by design-builder is ongoing.
 - Sound wall installation at the Reeves staging yard is anticipated to be completed in March 2019.
 - MOA approved by the City of Beverly Hills



Soldier Pile Installation in Century City



AT&T Parking Structure Demolition in Century City

March 2019



On target



Possible problem



Major issue

Construction Committee

Los Angeles County Metropolitan Transportation Authority



Metro 6

WESTSIDE PURPLE LINE EXTENSION – SECTION 3

OK BUDGET

	<u>Current</u>	<u>Forecast</u>
TOTAL COST*	TBD	\$3,713M

* Includes finance costs.

OK SCHEDULE

	<u>Current</u>	<u>Forecast</u>
REVENUE OPERATION	TBD	2027

- C1151 Tunnel Contract – Contract award to Frontier-Kemper/Tutor Perini Joint Venture was issued on November 30, 2018 and Notice to Proceed was issued on January 15, 2019. The Pre-Construction (kick-off) Meeting was held on January 16, 2019.
- C1152 Stations, Trackwork and Systems Contract – Notice to Proceed is subject to FTA’s approval of a Full Funding Grant Agreement (FFGA).
- C1153 Advanced Utility Relocations (AUR) Contract – Overall progress is 72% complete.
- Issued a work order to MCI to relocate Verizon and Frontier telecommunication lines into a single joint trench on December 18, 2018. Construction started on February 11, 2019.



Ductbank Trench Excavation



Main Line A and Lateral A7 Excavation and Potholing

March 2019



On target



Possible problem



Major issue

Construction Committee

Los Angeles County Metropolitan Transportation Authority



Metro 7

PATSAOURAS PLAZA BUSWAY STATION

 BUDGET	<u>Current</u>	<u>Forecast</u>
TOTAL COST	\$39.7M	\$TBD

 SCHEDULE	<u>Current</u>	<u>Forecast</u>
SUBSTANTIAL COMPLETION	Winter 2018	March 2020

- Overall project progress remains at approximately 65% complete
- Project contractor and construction suspension continues since April 24, 2018 due to archaeological and Native American resource issues
 - Project team is working diligently to resume construction with FTA and the consulting parties by late March 2019
- Archaeological investigation and treatment field work began on November 12, 2018, and expected to be completed March 2019
 - To date 35 archaeological features including human remains discovered
- Archaeological and Native American issues will deplete project contingency, requiring Life of Project (LOP) budget increase
 - Metro concluded global settlement negotiations with contractor on December 14, 2018, with expected Board Report in April 2019

March 2019



On target



Possible problem



Major issue

Construction Committee

Los Angeles County Metropolitan Transportation Authority



Metro 8

WILLOWBROOK/ROSA PARKS STATION



BUDGET

	<u>Current</u>	<u>Forecast</u>
TOTAL COST	\$109.3M	\$109.3M



SCHEDULE

	<u>Current</u>	<u>Forecast</u>
SUBSTANTIAL COMPLETION	Summer 2020	Summer 2020

- Package A: Utility Work in progress with main cisterns installed. Structural components and framing for Customer Service and Mobility Hub Building in progress
- Package C: Demolition started on Blue Line Platform and Mezzanine with shut down of Blue Line
- Package B: Finalizing 100% bid Package.



Construction and Demolition for Package A+C

March 2019



On target



Possible problem



Major issue

Construction Committee

Los Angeles County Metropolitan Transportation Authority



Metro 9

THE NEW BLUE

BUDGET		
	Current	Forecast
TOTAL COST	\$221.3M	\$221.3M

SCHEDULE		
	Current	Forecast
SUBSTANTIAL COMPLETION	Fall 2019	Fall 2019

- Metro Blue Line south segment shutdown started on January 26, 2019
- Rail replacement and rebooting 35% complete
- Overhead Catenary System (OCS) demolition work is 40% complete
- Compton new interlocking track work completed and new bungalows installed
- All construction work is proceeding per schedule and inclement weather mitigations are in place as necessary.



Rail Replacement at Long Beach



Compton New Train Control Bungalow



Overhead Catenary System Demolition

March 2019



On target



Possible problem



Major issue

Construction Committee

Los Angeles County Metropolitan Transportation Authority



Metro

I-210 BARRIER REPLACEMENT PROJECT

BUDGET		
	Current	Forecast
TOTAL COST	\$11.08M	\$22.62M
	Design	Design

SCHEDULE		
	Current	Forecast
Complete Design (Proj 1)	Summer 2019	Summer 2019
Complete Design (Proj 2)	Spring 2020	Spring 2020

- Conducting traffic micro-simulation studies to quantify the traffic delays during construction which are expected to be beyond the normal acceptable range and provide for effective mitigation measures. This traffic analysis is scheduled to be completed by mid-April 2019.
- Coordinating mitigation measures with Caltrans to address existing non-standard freeway features and other non-standard features caused by this project. Draft document to be submitted to Caltrans for Project 1 by end of March 2019
- Project 1: Segment from Michillinda to Iconic Bridge – Continuing surveying & environmental studies
- Project 2: Segment from west end of the project to Michillinda – Continuing traffic micro-simulation studies
- Separate Board report to request authorization to complete final design.



Newly Installed Caltrans Freeway Sign



Incident in 2014



Newly Installed Speed Limit Sign

March 2019



On target



Possible problem



Major issue

Construction Committee

Los Angeles County Metropolitan Transportation Authority



Metro 11

I-5 Construction Projects (By Caltrans)



March 2019

Construction Committee

Los Angeles County Metropolitan Transportation Authority



Metro

I-5 NORTH: SR 118 TO SR 134



! BUDGET		
TOTAL COST	Current \$880.9M	Forecast TBD

◇ SCHEDULE		
ANTICIPATED PROJECT COMPLETION	Current Spring 2022	Forecast Summer 2022

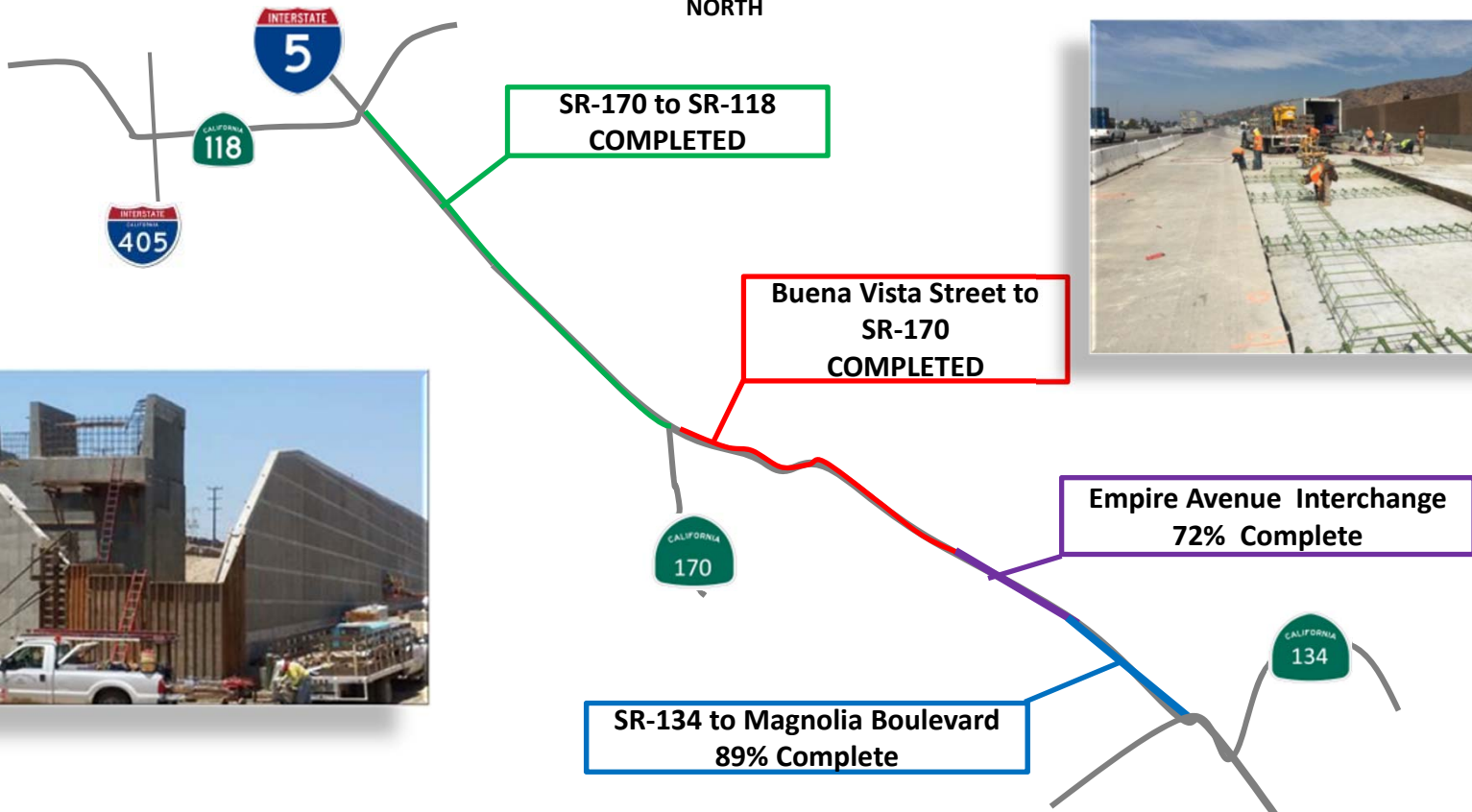

March 2019



On target



Possible problem



Major issue

Construction Committee

Los Angeles County Metropolitan Transportation Authority



Metro 13

I-5 SOUTH: ORANGE COUNTY LINE TO I-605



OK BUDGET		
	Current	Forecast
TOTAL COST	\$1.888B	TBD

◇ SCHEDULE		
	Current	Forecast
ANTICIPATED PROJECT COMPLETION	Summer 2022	Fall 2022

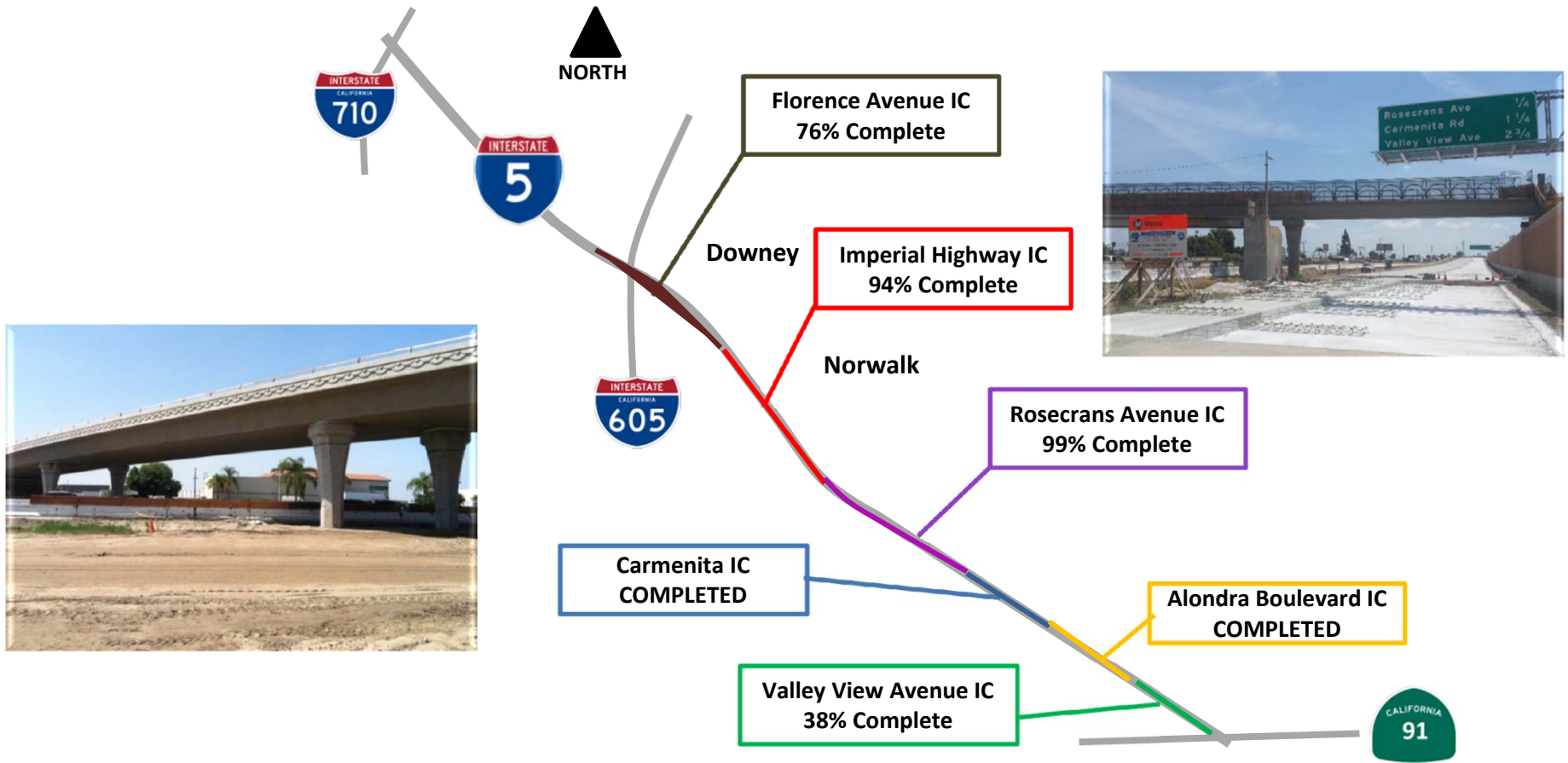

Crenshaw/LAX Transit Project

Project Cost Contingency Drawdown

January 2019

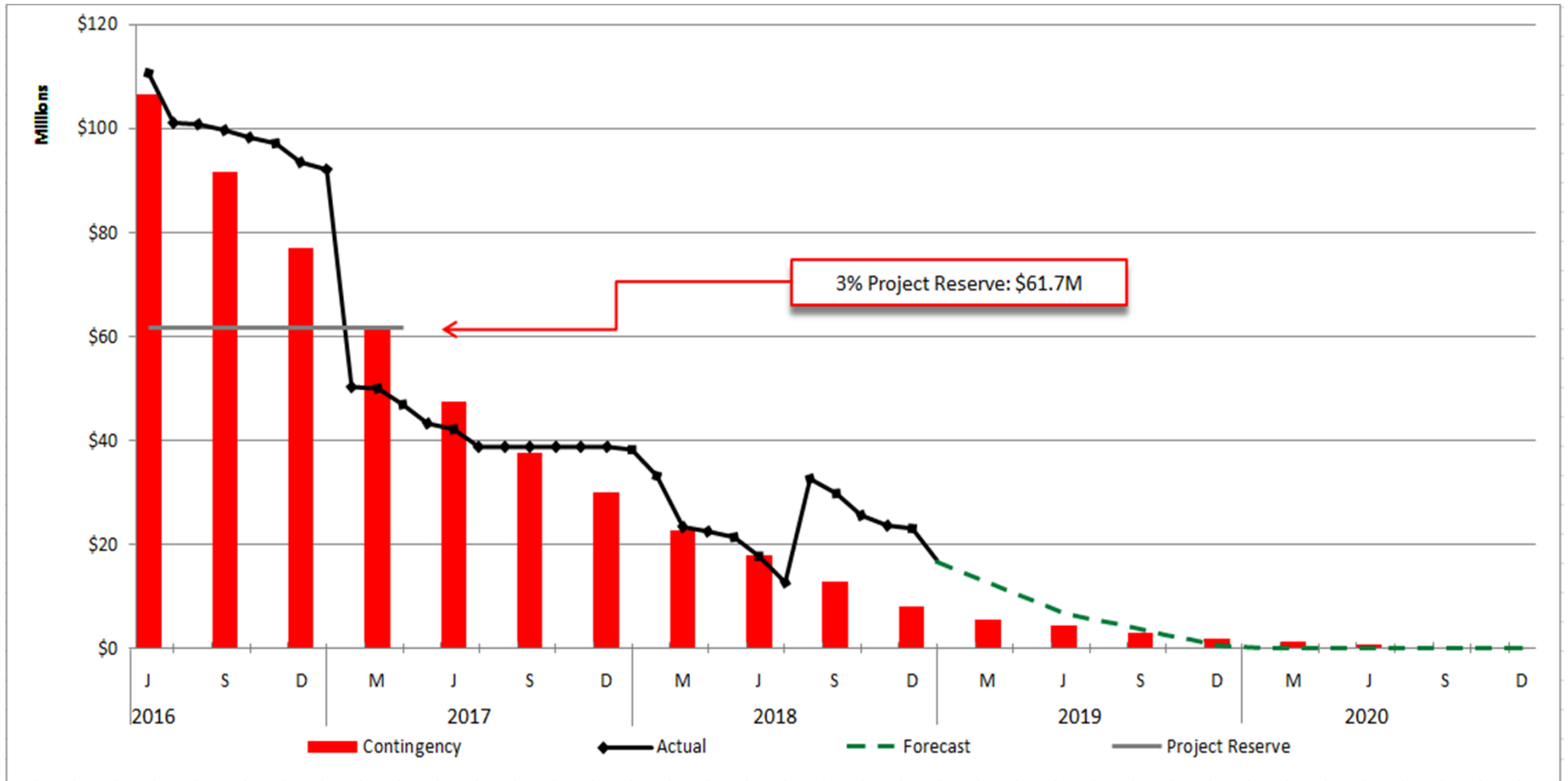

Regional Connector

Project Cost Contingency Drawdown

January 2019

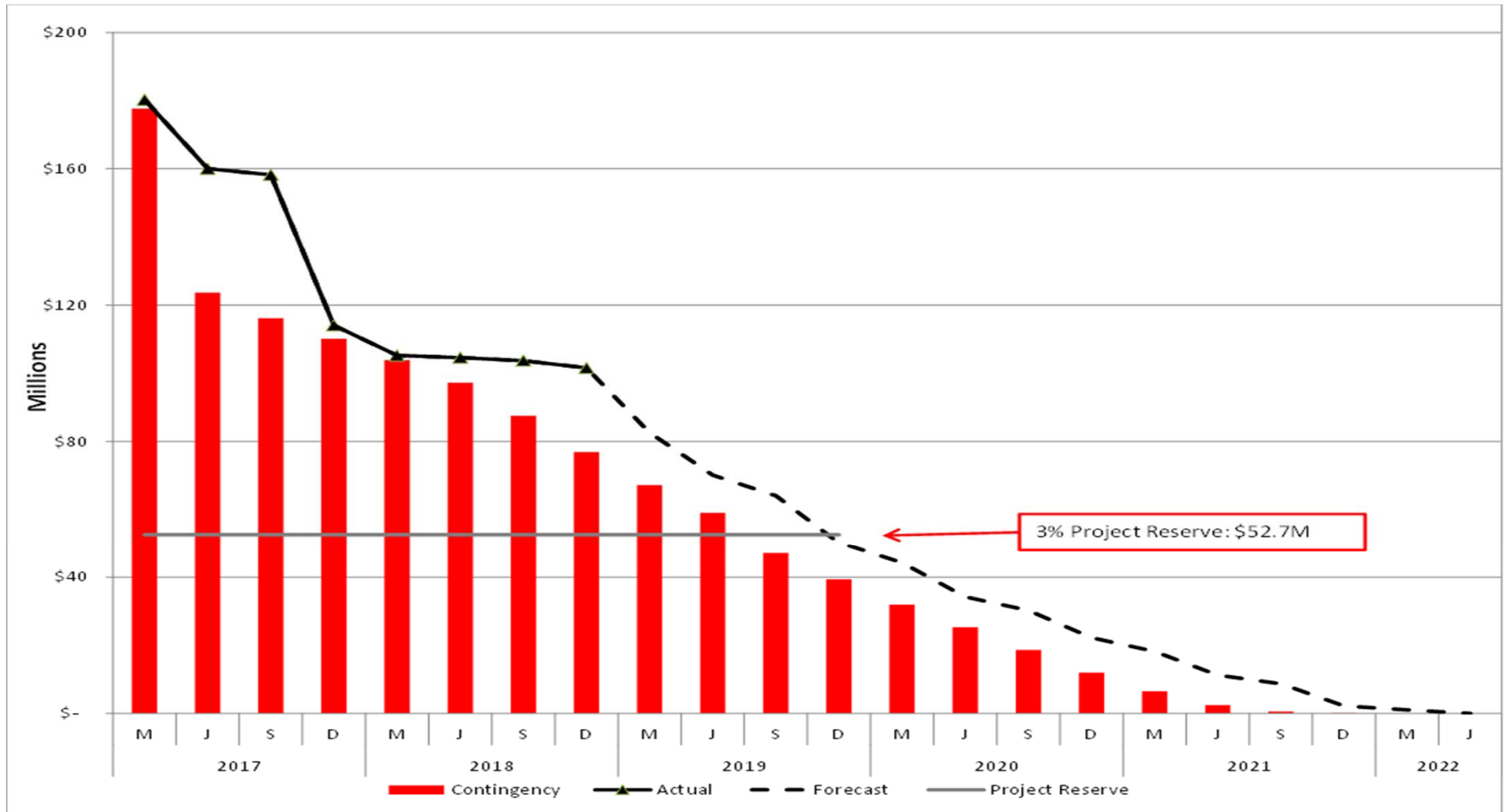

Westside Purple Line Extension – Section 1

Project Cost Contingency Drawdown

January 2019

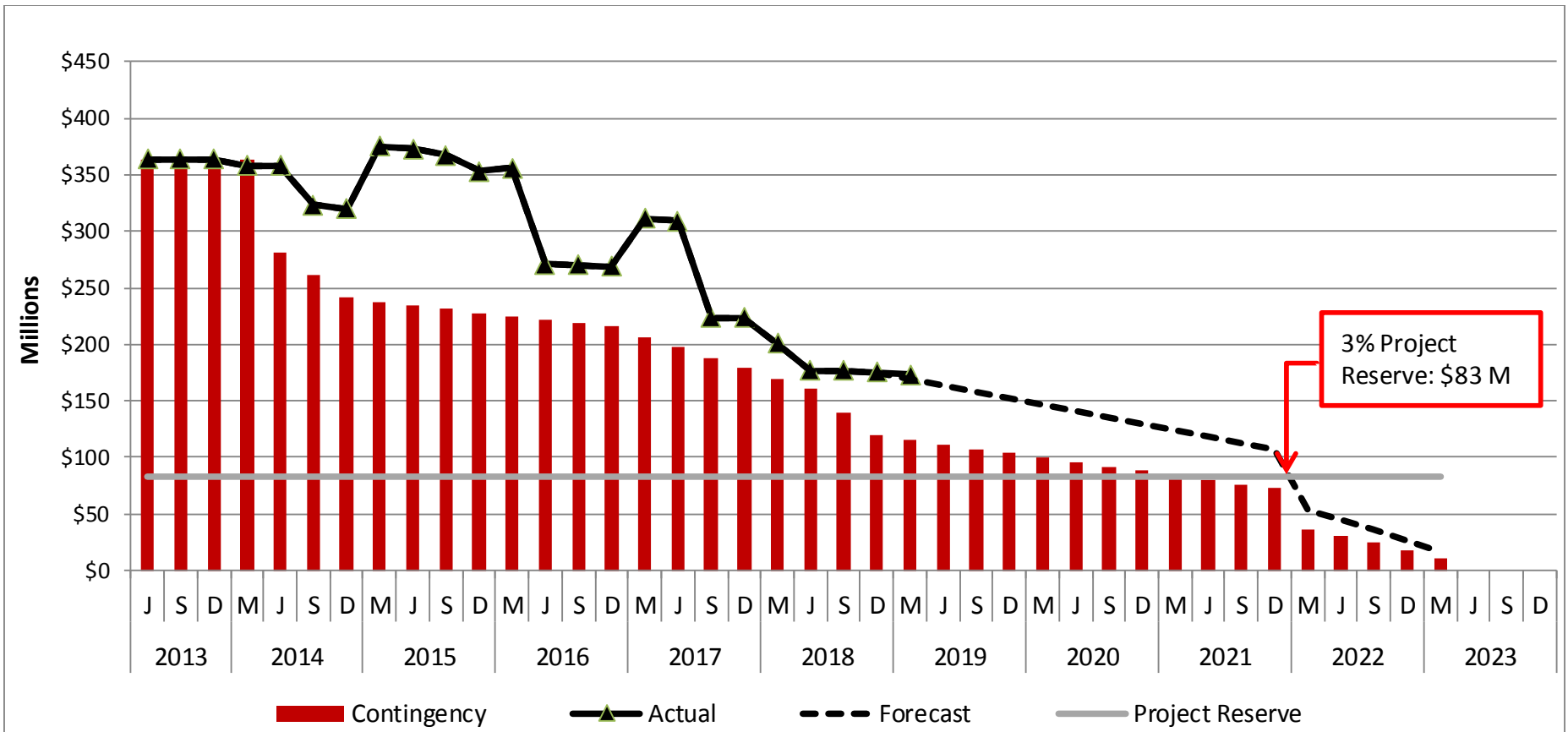

Westside Purple Line Extension – Section 2

Project Cost Contingency Drawdown

January 2019

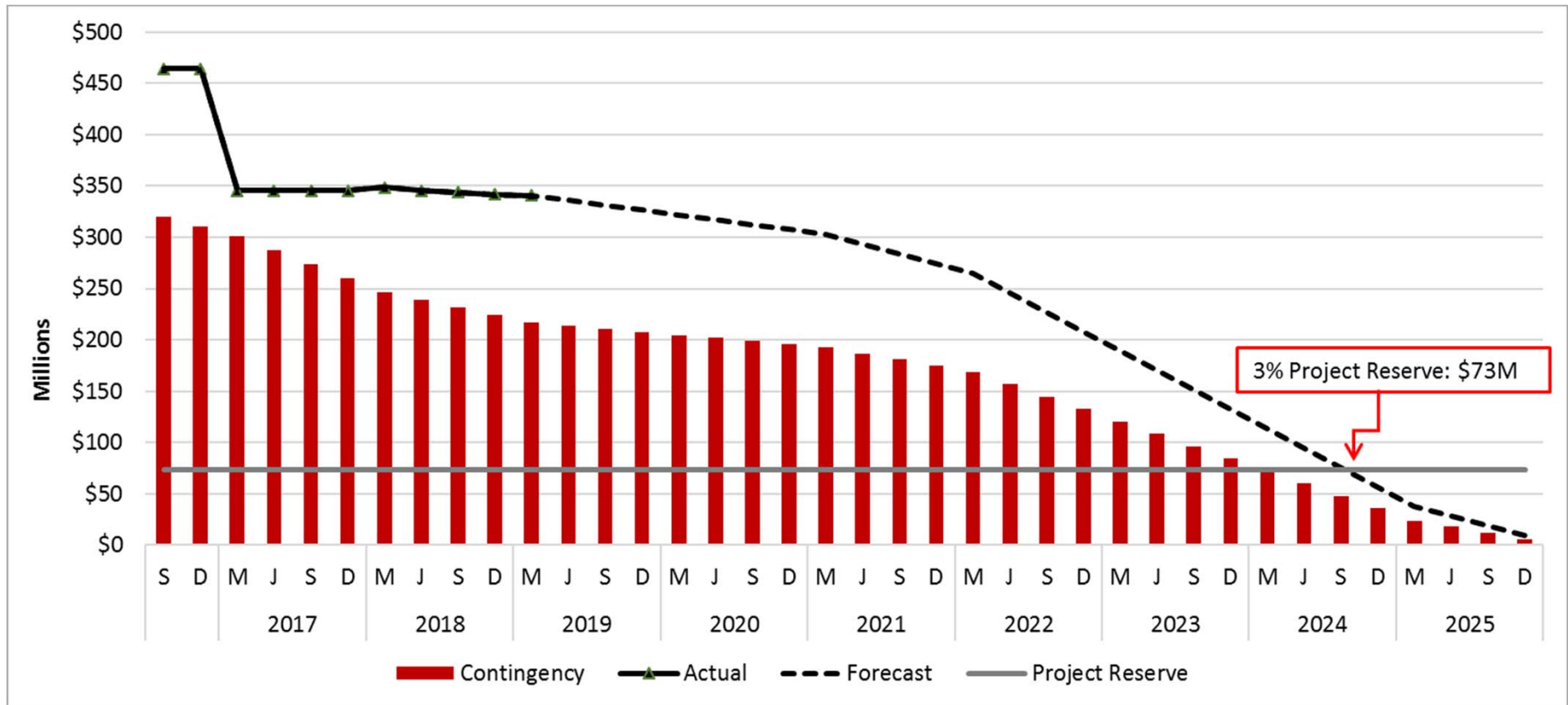

The New Blue

Project Cost Contingency Drawdown

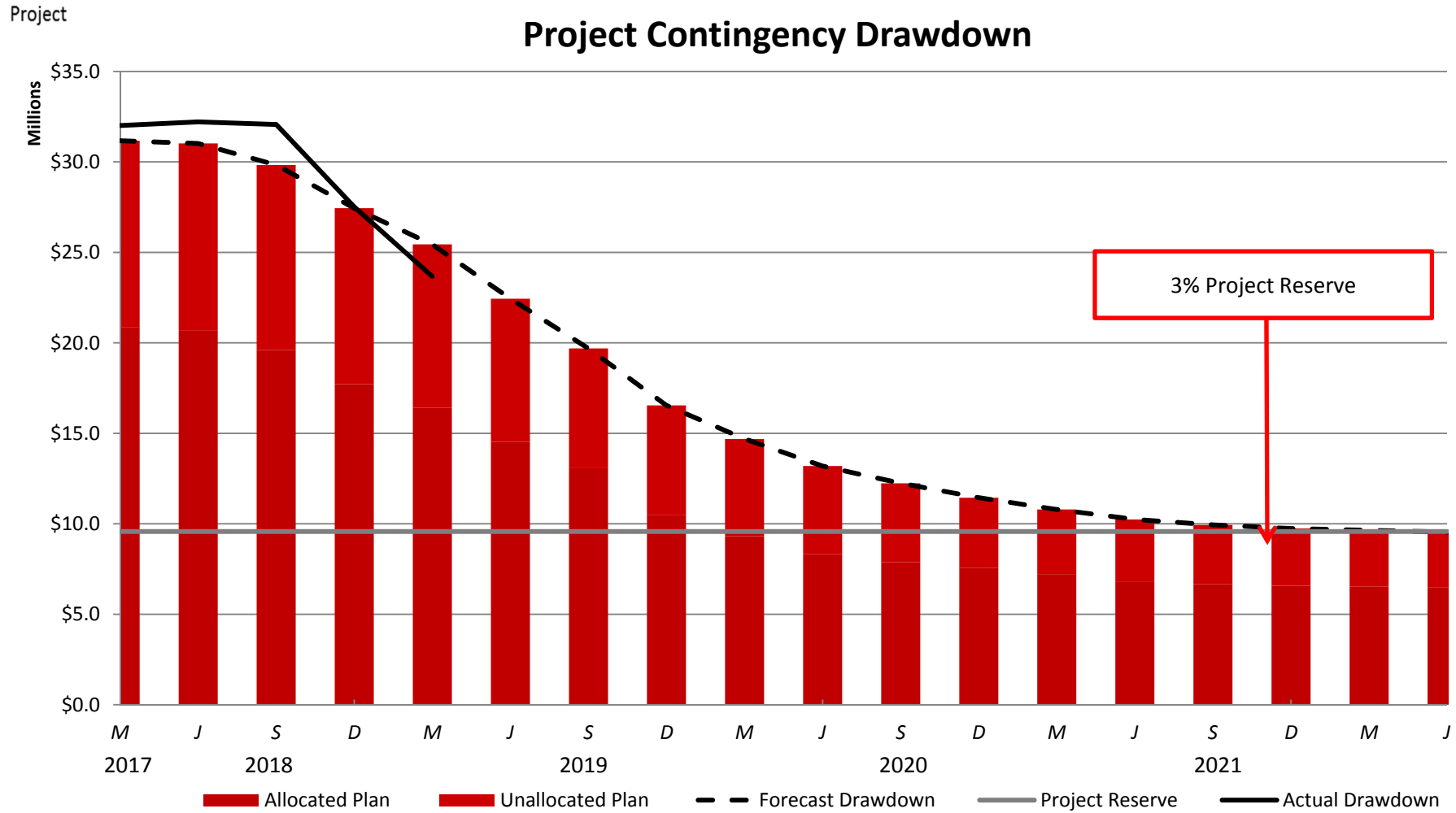

- Blue Line Signal Rehabilitation
- Blue Line Track and System Refurbishment
- Willowbrook/Rose Park Station



Board Report

File #: 2019-0032, **File Type:** Informational Report

Agenda Number: 28.

**CONSTRUCTION COMMITTEE
EXECUTIVE MANAGEMENT COMMITTEE
MARCH 21, 2019**

SUBJECT: PROJECT LABOR AGREEMENT/CONSTRUCTION CAREERS POLICY (PLA/CCP)

ACTION: RECEIVE AND FILE

RECOMMENDATION

RECEIVE AND FILE the:

- A. Status update on the Project Labor Agreement and Construction Careers Policy programs through the quarter ending December 2018; and
- B. Women in the Trades Action Plan.

ISSUE

In January 2012, the Board approved the Project Labor Agreement (PLA) with the Los Angeles/Orange Counties Building and Construction Trades Council and the Construction Careers Policy (CCP), with a subsequent renewal in January 2017. The PLA/CCP encourages construction employment and training opportunities for members of economically disadvantaged areas throughout the United States on Metro's construction projects. An added value of the PLA is that work stoppages are prohibited.

This report provides an update on the PLA/CCP through the quarter ending December 2018.

BACKGROUND

Consistent with the Board approved PLA and CCP (PLA/CCP), prime contractors are required to provide Metro with monthly reports detailing progress towards meeting the targeted worker hiring goals. Additionally, consistent with Metro's Labor Compliance policy and federal Executive Order 11246 (EO 11246), the prime contractors provide Metro with worker utilization data by ethnicity and gender. In accordance with EO 11246, Metro's program-wide goal for female participation on PLA/CCP construction projects is 6.90%.

Metro staff has continued to advance several initiatives with focus on increasing the overall female participation attainment such as: development of an action plan as presented in November 2017, deployment of a performance score card including development and distribution of Women in the

Trades Resource Guide, and continued engagement with Metro’s prime contractors and job coordinators with a focus on female worker outreach and retention. As a result of the focused initiatives, Metro’s female participation attainment on active projects has steadily increased from October 2017 reporting of 3.34% to 3.62% as of December 2018. The overall increase is attributed to 132 new female workers being employed on Metro’s construction projects between November 2017 and December 2018. The quarterly report indicates a total increase of 17 female workers employed between October 2018 and December 2018.

DISCUSSION

This report provides a status update on the construction contracts covered by the PLA/CCP, including an overview of Diversity and Economic Opportunity Department (DEOD) staff’s efforts on the female participation action plan, and an update on the construction projects covered under the Pilot Local Hire Initiative. The report also provides an update on outreach activities in support of targeted workforce initiatives.

A. PLA/CCP Status Update

As of December 2018, there are twelve active construction contracts with PLA/CCP program requirements including two contracts subject to the Pilot Local Hire Initiative. Ten of the twelve contractors exceed the 40% Targeted Worker goal, five contractors exceed the 20% Apprentice Worker goal, and six contractors exceed the 10% Disadvantaged Worker goal.

There are seventeen completed construction contracts. The information on the completed construction contracts is provided as Attachment A.

The following table represents the active construction projects as of the December 2018 quarterly reporting period.

Active Construction Projects

Project Name:	Prime Contractor:	Targeted Worker Goal (40%)	Apprentice Worker Goal (20%)	Disadvantaged Worker Goal (10%)	Female Utilization Goal (6.90%)	Percentage of Disadvantaged Worker Participation that are in the Criminal Justice System Category *
Crenshaw/LAX Transit Corridor	Walsh/Shea Corridor Constructors	60.22%	23.22%	12.23%	3.71%	34.86%
Regional Connector Transit Corridor	Regional Connector Constructors, JV	58.89%	16.09%	9.00%	3.26%	73.20%
Westside Subway Extension Project, Section 1 – D/B	Skanska-Traylor-Shea, JV	64.19%	17.54%	10.40%	4.04%	73.96%
Division 16 Southwestern Yard	Hensel Phelps/Herzog, JV	49.26%	29.25%	10.25%	4.01%	79.60%
Patsaouras Plaza Busway Station	OHL-USA, Inc.	57.36%	12.58%	4.08%	1.22%	58.22%
New Maintenance of Way/Non Revenue Vehicle Building 61S	Clark Construction, Inc.	62.82%	25.28%	11.72%	0.65%	65.12%
Division 1 Maintenance Annex Bldg.	Metro Builders, Inc.	43.70%	19.98%	14.29%	5.49%	1.31%
Division 9 Maintenance Annex Bldg.	Metro Builders, Inc.	43.63%	26.85%	9.43%	1.07%	84.22%
Westside Purple Line Extension Project, Section 3 Advanced Utility Relocations	Bubalo Construction Co.	46.66%	21.15%	11.20%	4.04%	0.00%
Metro Blue Line Signal System Rehabilitation	Mass Electric Construction	14.87%	12.66%	2.50%	0.00%	0.00%
Soundwall #11 Construction	Powell Constructors, Inc.	32.59%	10.66%	0.21%	0.02%	100%
Willowbrooks/Rosa Parks Station Improvements	Icon-West	63.10%	19.00%	0.00%	0.00%	0.00%

Please refer to the attached PLA/CCP Data Report for additional information on each project.

*Part of Metro's PLA/CCP workforce requirement is the utilization of disadvantaged workers on projects. One of the nine criteria for a Disadvantaged Worker is having a

criminal record or other involvement with the criminal justice system. The data shown in the table above (last column) is the percentage of Disadvantaged Workers (based on hours worked) that have criminal records or involvement with the criminal justice system and that have worked or, are actively working, on Metro's PLA/CCP projects.

Crenshaw/LAX Transit Corridor
Prime: Walsh/Shea Corridor Constructors

The Crenshaw/LAX Transit Corridor project contractor has completed 91.79% of the estimated construction work hours for this project. The contractor currently exceeds the Targeted Worker goal at 60.22%, Apprentice Worker Goal at 23.22%, Disadvantaged Worker goal at 12.23% and the minority participation percentage goals. The attainment for the 20% Apprentice Worker goal is based on total apprentice hours.

Although the contractor is not meeting the 6.90% Female Participation goal, the overall attainment has increased in direct relation to the efforts that have been initiated by the contractor.

Staff issued an Executive Order 11246 Notice in September 2017 requesting the prime contractor to document efforts related to the recruitment of female workers as part of their efforts to increase female participation. The contractor has increased the female participation from 3.27% in September 2017 to 3.71% as of this reporting cycle, reflecting a total of 170 female workers hired on the project.

Regional Connector Transit Corridor
Prime: Regional Connector Constructors, Joint Venture

The Regional Connector Transit Corridor project contractor has completed 52.61% of the estimated construction work hours for this project. The contractor currently exceeds the Targeted Worker goal at 58.89% and the minority participation percentage goals; however, the contractor is not meeting the 20% Apprentice Worker goal at 16.09%, or the 10% Disadvantaged Worker goal at 9.00%. The attainment for the 20% Apprentice Worker goal is based on total apprentice hours.

The contractor has provided an updated Employment Hiring Plan (EHP) which outlines compliance with meeting the PLA/CCP workforce goals in the latter part of 2019. Staff will continue to monitor the contractor's EHP and work closely with the contractor towards meeting all worker goals for this project.

The contractor is not meeting the 6.90% Female Participation goal at 3.26%. Staff issued an Executive Order 11246 in February 22, 2018 and met with the prime contractor along with the job coordinator. Staff continues to monitor the contractor's performance based on the plan to perform more focused outreach. In addition, the contractor and the job coordinator have supported Metro staff outreach efforts to former female workers on the project, which include conducting an informal exit

interview to gather insights into their experiences while working on the project and understanding their reasons for transitioning from the project, and possibly the construction industry. A total of 74 female workers were hired on the project as of this reporting period.

Westside Subway Extension Project, Section 1 Design-Build
Prime: Skanska-Traylor-Shea, a Joint Venture (STS)

The Westside Subway Extension Project, Section 1 project contractor has completed 46.85% of the estimated construction work hours for this project. The contractor currently exceeds the Targeted Worker goal at 64.19%, Disadvantaged Worker goal at 10.40%, and the minority participation percentage goals; however, the contractor is not meeting the 20% Apprentice Worker goal at 17.54%. The attainment for the 20% Apprentice Worker is based on total apprentice hours.

The contractor has provided an updated EHP, which outlines compliance with meeting the PLA/CCP workforce goals in the latter part of 2022. Staff will continue to monitor the contractor's EHP and work closely with the contractor towards meeting all worker goals for this project.

The contract is not meeting the 6.90% Female Participation goal at 4.04%. Staff issued an Executive Order 11246 Notice on February 20, 2018 and met with the prime contractor along with their job coordinator on February 28, 2018 to discuss the female participation on this project. The contractor committed to perform more outreach activities focusing on female recruitment as part of their effort to increase female participation. As of this reporting period, the contractor conducted a meeting with all their sub-contractors to encourage hiring of female workers. A total of 73 female workers were hired on the project as of this reporting period.

Division 16 - Southwestern Yard
Prime: Hensel Phelps/Herzog, J.V.

The Division 16 Southwestern Yard project contractor has completed 97.07% of the estimated construction work hours on this project. The contractor currently exceeds the Local Targeted Worker goal at 49.26%, Apprentice Worker goal at 29.25%, Disadvantaged Worker goal at 10.25%, and the minority participation percentage goals. The attainment for the 20% Apprentice Worker is based on total apprentice hours.

This contract falls under the United States Department of Transportation's (U.S. DOT) Local Hire Pilot Program.

Although the contractor is not meeting the 6.9% Female Participation goal at 4.01%, the female worker attainment for this project is one of the highest as of this reporting period. Staff issued an Executive Order 11246 Notice in February 2018 requesting the prime contractor to document efforts related to the recruitment of female workers as part of their effort to increase female participation. The contractor, along with their job coordinator, committed to increase the female participation by performing targeted outreach and collaborating with community-based organizations in recruiting female workers. A total of 43 female workers have been hired on the project as of this reporting period.

Patsaouras Plaza Busway Station

Prime: OHL-USA, Inc.

The Patsaouras Plaza Busway Station project contractor has completed 83.35% of the estimated construction work hours on this project. The contractor currently exceeds the Targeted Worker goal at 57.36% and the minority participation percentage goals; however, the contractor is not meeting the 20% Apprentice Worker goal at 12.58% or the 10% Disadvantaged Worker goal at 4.08%. The attainment for the 20% Apprentice Worker is based on total apprentice hours.

Metro staff issued a Notice of Non-Compliance in November 2017 for the low attainment of the Apprentice and Disadvantaged Worker goals. The contractor submitted a revised EHP with an action plan for meeting all PLA/CCP workforce provisions by the end of the project. As of this reporting cycle, the contractor continues to show progress in the Apprentice Worker attainment and has committed in hiring more disadvantaged workers. Staff will continue to monitor the contractor's EHP and will work closely with the contractor towards meeting all worker goals for this project.

The contractor is not meeting the 6.90% Female Participation goal at 1.22%. Staff issued an Executive Order 11246 Notice in February 2018 requesting the contractor to document efforts related to the recruitment of female workers as part of their effort to increase female participation. The contractor and their job coordinator committed to increase female participation by performing targeted outreach and collaborating with community-based organizations in recruiting female workers.

New Maintenance of Way/Non Revenue Vehicle Building 61S

Prime: Clark Construction, Inc.

The New Maintenance of Way/Non-Revenue Vehicle Building 61S project contractor has completed 92.98% of the estimated construction work hours for this project. The contractor currently exceeds the Targeted Worker goal at 62.82%, Apprentice Worker goal at 25.28%, Disadvantaged Worker goal at 11.72% and the minority participation percentage goals. The attainment for the 20% Apprentice Worker is based on total apprentice hours.

The contractor is not meeting the 6.90% Female Participation goal at 0.65%. Staff issued an Executive Order 11246 Notice in May 2018 and met with the prime contractor along with their job coordinator to discuss the low female participation on this project. The contractor committed to perform more outreach activities focusing on female recruitment as part of their effort to increase female participation. The contractor hired a total of 9 female workers into the project as of this reporting period.

Division 1 Maintenance Annex Building

Prime: Metro Builders, Inc.

The Division 1 Maintenance Annex Building project contractor has completed 84.64% of the estimated construction work hours on this project. The contractor currently exceeds the Targeted Worker goal at 43.70%, Disadvantaged Worker goal at 14.29% and the minority participation goals;

however, the contractor is not meeting the 20% Apprentice Worker goal at 19.98%. The attainment for the 20% Apprentice Worker is based on total apprentice hours.

Staff will continue to monitor the contractor's EHP and work closely with the contractor to meet all worker goals for this project.

Although the female participation attainment is the highest as of this reporting period, the contract is not meeting the 6.90% Female Participation goal at 5.49%. Staff issued a Female Participation Notice on December 2018 reminding the contractor of the 6.9% female participation goal.

Division 9 Maintenance Annex Building

Prime: Metro Builders, Inc.

The Division 9 Maintenance Annex Building project contractor has completed 98.91% of the estimated construction work hours on this project. The contractor currently exceeds the Targeted Worker goal at 43.63%, Apprentice Worker goal at 26.85% and the minority participation goals; however, the contractor is not meeting the 10% Disadvantaged Worker goal at 9.43%. The attainment for the 20% Apprentice Worker is based on total apprentice hours.

The contractor is not meeting the 6.90% Female Participation goal at 1.07%. Staff issued a Female Participation Notice on December 2018 reminding the contractor of the 6.90% female participation goal. The contractor responded indicating that female workers currently working for the Division 1 Maintenance Annex Building project, which is near completion, will be transitioned to the Division 9 Maintenance Annex Building project in support of female worker retention.

Westside Purple Line Ext. Section 3 - Advanced Utility Relocations

Prime: Bubalo Construction Co.

The Westside Purple Line Ext. Section 3 - Advanced Utility Relocations project contractor has completed 86.43% of the estimated construction work hours on this project. The contractor currently exceeds the Local Targeted Worker goal at 46.66%, Apprentice Worker goal at 21.15%, Disadvantaged Worker goal at 11.20% and the minority participation percentage goals. The attainment for the 20% Apprentice Worker is based on total apprentice hours.

This contract falls under the U.S. DOT Local Hire Pilot Program.

The contractor is not meeting the 6.9% Female Participation goal at 4.04%. Staff issued an Executive Order 11246 Notice in July 27, 2018 and met with the prime contractor along with their job coordinator on August 7, 2018 to discuss the low female participation on this project. The contractor committed to perform more outreach activities focusing on female recruitment as part of their effort to increase female participation.

Metro Blue Line Signal System (Rehabilitation)

Prime: Mass Electric Construction Co.

The Metro Blue Line Signal System (Rehabilitation) project contractor has completed 14.21% of the estimated construction work hours on this project. The contractor is meeting the minority participation

goals; however, the contractor is not meeting the 40% Targeted Worker goal at 14.87%, the 20% Apprentice Worker goal at 12.66% or the 10% Disadvantaged Worker goal at 2.50%. The attainment for the 20% Apprentice Worker is based on total apprentice hours.

The contractor has submitted an EHP which outlines compliance with meeting the PLA/CCP workforce goals at the latter part of 2019. Staff will continue monitoring the contractor's EHP and work closely with the contractor in meeting all worker goals for this project.

There is currently no female participation on this project. The project is at the early stage of construction with 14.21% project completion. Staff will issue a Female Participation Notice to the contractor.

Soundwall #11 Construction
Prime: Powell Constructors, Inc.

The Soundwall #11 Construction project contractor has completed 12.85% of the estimated construction work hours on this project. The contractor is meeting the minority participation goals; however, the contractor is not meeting the 40% Targeted Worker goal at 32.59%, the 20% Apprentice Worker goal at 10.66% or the 10% Disadvantaged Worker goal at 0.21%. The attainment for the 20% Apprentice Worker is based on total apprentice hours.

The contractor has submitted an EHP which outlines compliance with meeting the PLA/CCP workforce goals at 65% project completion. Staff will continue monitoring the contractor's EHP and work closely with the contractor in meeting all worker goals for this project.

The contractor is not meeting the 6.90% Female Participation goal at 0.02%. The project is at the early stage of construction with 12.85% project completion. Staff will issue a Female Participation Notice to the contractor.

Willowbrooks/Rosa Parks Station Improvements
Prime: Icon-West Inc.

The Willowbrooks/Rosa Parks Station Improvements project contractor has completed 9.85% of the estimated construction work hours on this project. The contractor currently exceeds the Targeted Worker goal at 63.10% and the minority participation goals; however, the contractor is not meeting the 20% Apprentice Worker goal at 19.00% or the 10% Disadvantaged Worker goal at 0.00%. The attainment for the 20% Apprentice Worker is based on total apprentice hours.

The contractor has submitted an EHP which outlines compliance with meeting the PLA/CCP workforce goals at 40% project completion. Staff will continue to monitor the contractor's EHP and work closely with the contractor in meeting all worker goals for this project.

There is currently no female participation on this project. The project is at the early stage of construction with 9.85% project completion. Staff will issue a Female Participation Notice to the contractor.

Female Workers on Active Construction Projects

In consideration of ongoing efforts to review and report on Metro's female participation attainment, the following table highlights the number of cumulative female workers on active PLA/CCP projects within the last three months.

Project Name:	Prime Contractor:	No. of Female Workers October 2018	No. of Female Workers November 2018	No. of Female Workers December 2018
Crenshaw/LAX Transit Corridor	Walsh/Shea Corridor Constructors	166	167	170
Regional Connector Transit Corridor	Regional Connector Constructors, JV	71	72	74
Westside Subway Extension Project, Section 1	Skanska-Traylor-Shea, JV	73	73	73
Division 16 - Southwestern Yard	Hensel Phelps/Herzog, JV	41	43	46
Patsaouras Plaza Busway Station	OHL, USA, Inc.	2	3	3
New Maintenance of Way/Non Revenue Vehicle Bldg. 615	Clark Construction, Inc.	9	9	9
Division 1 Maintenance Annex Bldg.	Metro Builders, Inc.	2	3	3
Division 9 Maintenance Annex Bldg.	Metro Builders, Inc.	1	2	2
Westside Purple Line Extension Section 3 Advanced Utility Relocations	Bubalo Construction Inc.	2	2	2
Metro Blue Line Signal System Rehabilitation	Mass Electric Company	0	0	0
Soundwall #11 Construction	Powell Constructors	0	0	1
Willowbrooks/Rosa Parks Stations Improvements	Icon-West	0	0	0

B. Women in the Trades Action Plan

Following is an update on efforts that are underway as of this reporting period.

- Women in the Trades Resource Guide: Staff developed a resource guide to provide contractors and job coordinators the industry best practices for outreach, recruitment, training and retention of workers with special focus on the outreach and recruitment of women. The resource guide contains support services, best practices and other areas of focus that have been identified by female workers and organizations such as Women In Non-Traditional Employment Roles (WINTER), all identified as vital to achieve a sustained career in the

construction industry. The Women in the Trades Resource Guide is published on Metro's PLA/CCP website and has been distributed to Metro's prime contractors, job coordinators and the LA/OC Building and Construction Trades Council. The guide will also be released via wide circulation to community based organizations and various industry sector publications.

Status: Completed

Milestone: Initiated development in early 2018; published in Oct 2018

- Job Coordinators Consulting Engagement Review: Staff has initiated efforts for the formal assessment of the active job coordinators' outreach and recruitment practices including overall processes in support of identifying best practices and/or areas of enhancement or modification. The effort is being conducted with the support of Metro's Audit Management Services Department. Staff will also leverage the results of the assessment and recommendations in the Request for Qualifications to re-establish the job coordinator panel.

Status: In process

Milestone: MASD has issued a draft report with proposed recommendations.

- Regional Construction Industry Workforce Disparity Study: A solicitation was issued for a comprehensive workforce disparity study to determine the availability of women in the construction trades throughout the Los Angeles County region. The study will identify the demand for construction labor by Metro and other agencies in the region, the available labor supply including labor supply constraints, and other considerations. The Request for Proposal was issued in April 2018 and the contract was awarded to Estalano Lesar Advisors on August 22, 2018. The study was initiated in August 2018 and Metro staff along with the consultant met with the Building Trades Executive Board to provide an introduction to the disparity study and request ongoing support throughout the effort.

Status: In process

Milestone: Initiation of the study in August 2018; and projected completion in March 2019

DEOD staff will continue to focus on strategies to support the outreach, recruitment and retention of women into the trades with specific focus on Metro's PLA/CCP construction projects. Recognizing the need to promote retention, professional development and career advancement, staff has begun to implement strategies to support retention and development of female workers on Metro's construction projects.

Strategies include:

- Quarterly Jobs Coordinator Meetings: Staff continues to host quarterly meetings with the job coordinators to discuss best practices, identify outreach and recruitment opportunities, review the female participation scorecard, and focus on worker retention and transition among Metro projects. The next quarterly meeting is scheduled for April 2019.
- Worker Retention Best Practices: Efforts have been initiated to identify and assess the available pre-apprenticeship training programs with a focus on those with demonstrated

success for candidate retention. Various best practices have been incorporated in the Women in the Trades Resource Guide. Staff is also looking into opportunities to strengthen retention tracking and reporting through the system software application, LCP Tracker.

- Transition Coordination: Staff has developed a formalized process to assist female workers to transition to other active or upcoming Metro projects as projects near the end of construction. The formalized process consists of the following actions:
 - Communicate female worker transition with prime contractors and jobs coordinators nearing 80% project completion;
 - Work with the jobs coordinators to identify female workers preparing for transition and available for work at least 30 days prior to project end date and/or worker assignment end date;
 - Provide female workers with a list of active jobs coordinators; and
 - Follow-up monthly/quarterly on recruitment and placement progress.
 - Provide updates in PLA/CCP quarterly reports.
- Staff performed exit interviews with several female workers at the end of their employment on Metro construction projects. The intent was to identify issues and provide insights in improving female retention on Metro projects. A high-level summary of the results are as follows:
 - Total of 14 female workers were surveyed with a 36% response rate
 - Over 50% of the female workers are still employed and working on non-Metro projects
 - 20% of the female workers have changed careers
 - 20% are unemployed and still interested in working in the construction industry. As of January 2019, Metro has confirmed that these females are working on other non-Metro projects (union dispatched).

The result of exit interviews will be utilized to improve retention and transition coordination to all workers.

Furthermore, staff will continue to provide ongoing assessment of the female participation score card, monitoring of contractor's performance, and recognition of contractors that successfully meet or exceed the 6.9% goal or demonstrate highly commendable efforts in the recruitment, retention and/or professional development of women on Metro's construction projects.

Lastly, a summary of Contractor's Action Plans to increase female workers in response to the issued EO 11246 Notices is provided as Attachment C.

C. Pilot Local Hire Update

On October 6, 2017, the Federal Register published a notice from the USDOT announcing the withdrawal of the Pilot Local Hire program. Metro has three construction projects awarded subject to the USDOT Pilot Local Hire Initiative which include:

- C0991 Division 16 - Southwestern Yard (contract value of \$172M)
- C1120 Westside Purple Line Extension Project - Section 2 (contract value of \$1.3B)
- C1153 Purple Line Extension Section 3 - Advanced Utility Relocations (contract value of \$11M).

In addition, Metro has seven rolling stock contracts that contain the Local Employment Plan (LEP).

- A650-2015 Heavy Rail Vehicle Overhaul
- P2000 Light Rail Vehicle Overhaul
- HR400 Purchase of New Heavy Rail Vehicles
- OP28367-000 Forty Foot (40') Low Floor CNG Buses
- OP28367-001 Sixty Foot (60') Low Floor Zero Emission Buses
- OP28367-002 Forty Foot (40') Low Floor Zero Emission Buses
- OP28367-003 Sixty Foot (60') Low Floor CNG Buses.

These combined seven projects will create new jobs in Los Angeles County totaling over \$62.3 million in wages and benefits over the next seven years. The LEP is projected to create an estimated 217 new jobs for the base and option contract terms for the seven projects.

D. Outreach

DEOD's Outreach team continuously seeks opportunities to keep the community informed and engaged of construction career opportunities available through Metro's PLA/CCP. Staff collaborates with community-based organizations and other partners including the contractors on outreach events, initiatives and activities. Staff hosted the following outreach event as of this reporting period:

- On November 8, 2018, the Metro "Women Build METRO LA" Committee conducted a quarterly Apprenticeship Readiness Fair symposium on the Transportation Industry at Los Angeles County Arboretum (5th District). It focused on the many opportunities for women in the transportation industry with special focus on the construction trades.

The next WBMLA event will be scheduled in May 2019. Metro will host a WBMLA event here at Metro HQ to reach a wider geographic area. In September 2019, the WBMLA Committee will host a symposium, to be conducted at L.A. Southwest College in the southern part of Los Angeles County.

Staff is exploring partnership opportunities between Metro, WINTER and the City and County of Los Angeles for support of an evening training cohort for construction pre-apprenticeship training.

NEXT STEPS

DEOD staff will continue to monitor contractor's efforts and initiate the various strategies and activities as outlined and will continue to use best practices, initiatives and outreach efforts to promote awareness, engagement and participation in construction career opportunities.

ATTACHMENTS

Attachment A - PLA/CCP Completed Contracts

Attachment B - PLA/CCP Update Report Data

Attachment C - Contractors Plan to Increase Female Participation

Prepared by: Michael Flores, Manager, Diversity and Economic Opportunity, PLA/CCP
and WIN-LA (213) 922-6387

Miriam Long, Director, Diversity and Economic Opportunity
(213) 922-7249

Victor Ramirez, Deputy Executive Officer, Vendor/Contract Management (213) 922-
1059

Shalonda Baldwin, Interim Executive Officer, Diversity and Economic
Opportunity (213) 418-3265

Reviewed by: Debra Avila, Chief, Vendor/Contract Management Officer (213) 418-3051

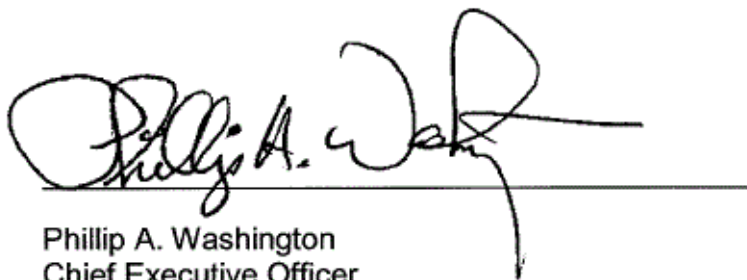

Phillip A. Washington
Chief Executive Officer

ATTACHMENT A

Completed Contracts:

Completed Projects:	Prime Contractor:	Targeted Worker Goal (40%)	Apprentice Worker Goal (20%)	Disadvantaged Worker Goal (10%)	Female Utilization Goal (6.90%)	*Percentage of Disadvantaged Workers that are in the Criminal Justice System Category
Crenshaw Advanced Utility Relocation Project	Metro Builders	61.41%	13.84%	21.08%	0.52%	2.90%
Westside Subway Extension Advanced Utility Relocation	Metro Builders	67.47%	11.12%	11.08%	7.48%	0.00%
Westside Subway Exploratory Shaft	Innovative Construction Solutions	50.88%	75.05%	11.23%	0.42%	96.23%
Regional Connector Transit Corridor Adv. Utility Relocation	Pulice Construction	51.61%	21.37%	22.83%	2.57%	28.39%
CNG Emergency Generator Division 7 & 8	Taft Electric	46.42%	25.51%	39.08%	4.68%	39.48%
Division 13 CNG Fueling Facility, Design/Build/Operate	Clean Energy	67.54%	20.17%	60.72%	1.69%	49.48%
Metro Blue Line Stations Refurbishments	S.J. Amoroso	56.01%	26.10%	13.62%	0.48%	28.03%
Westside Extension Project Advanced Utility Relocation (Fairfax Station)	WA Rasic	63.27%	20.61%	19.90%	2.78%	9.24%
Metro Rail Security Kiosks	Icon-West	45.90%	27.06%	20.17%	0.00%	100.00%
Westside Extension Project Advanced Utility Relocation (La Cienega Station)	Bubalo Construction	65.15%	21.76%	20.96%	0.57%	28.10%
MRL/MOL North Hollywood Station West Entrance	Skanska, USA	57.79%	24.28%	15.78%	7.44%	84.26%

Completed Projects:	Prime Contractor:	Targeted Worker Goal (40%)	Apprentice Worker Goal (20%)	Disadvantaged Worker Goal (10%)	Female Utilization Goal (6.90%)	*Percentage of Disadvantaged Workers that are in the Criminal Justice System Category
Patsouras Plaza POV Relocation, Pavers and Storm Drain Repair	AP Construction	76.46%	21.26%	42.56%	3.91%	6.48%
Universal City Pedestrian Bridge	Griffith Company	38.33%	27.49%	12.55%	1.57%	48.51%
MRL Pershing Square Canopy Addition and Escalator Replacements	Clark Construction, LLC	50.62%	33.68%	14.12%	1.46%	86.41%
Bob Hope Airport/ Hollywood Way Station	CA Rasmussen, Inc.	42.77%	22.62%	12.71%	0.80%	69.38%
Non-Revenue Maintenance Bldg. at Vernon Yard	Access Pacific, Inc.	54.16%	20.90%	12.93%	7.64%	5.35%
Metro Blue Line Pedestrian and Swing Gates Installation	Icon-West	65.33%	25.61%	11.56%	1.02%	98.57%

Please refer to the attached PLA/CCP Data Report for additional information on each project.

Crenshaw Advanced Utility Relocation Project
Prime: Metro Builders

The Crenshaw Advanced Utility Relocation project is 100% complete as of September 2014. Final reporting shows the Targeted Worker attainment at 61.41%, Disadvantaged Worker attainment at 21.08% and the minority participation percentage goals were attained; however, the Contractor did not meet the 20% Apprentice Worker goal at 13.84% and the 6.90% Female Participation goal at 0.52%. The attainment for the 20% Apprentice worker goal is based on total apprenticeable hours. Metro staff met with the Contractor in January 2015 and executed liquidated damages for not meeting the apprentice goal for this project. The Contractor complied with Metro's liquidated damages and this issue is closed.

Westside Subway Extension Advanced Utility Relocation
Prime: Metro Builders

The Westside Subway Extension Advanced Utility Relocation project is 100% complete as of October 2014. Final reporting shows the Targeted Worker attainment at 67.47%, Disadvantaged Worker attainment at 11.08%, Female Participation attainment at 7.48% and the minority participation percentage goals were attained; however, the Contractor did not meet the 20% Apprentice Worker goal at 11.12%. The attainment for the 20% Apprentice worker goal is based on total apprenticeable hours. Metro staff met with the Contractor in January 2015 and executed liquidated damages for not meeting the apprentice goal for this project. The Contractor complied with Metro's liquidated damages and this issue is closed.

Westside Subway Exploratory Shaft
Prime: Innovative Construction Solutions (ICS)

The Westside Subway Extension Exploratory Shaft project is 100% complete as of October 2014. Final reporting shows the Targeted Worker attainment at 50.88%, Apprentice Worker attainment at 75.05%, Disadvantaged Worker attainment at 11.23% and the minority participation percentage goals were attained; however, the Contractor did not meet the 6.90% Female Participation goal at 0.42%. The attainment for the 20% Apprentice worker goal is based on total apprenticeable hours. No labor grievances occurred on this project.

Regional Connector Transit Corridor Advanced Utilities Relocation
Prime: Pulice Construction

The Regional Connector Transit Corridor Advanced Utilities Relocation project was terminated for convenience in April 2015 and is now closed. Final reporting shows the Targeted Worker attainment at 51.61%, Apprentice Worker attainment at 21.37%, Disadvantaged Worker attainment at 22.83% and the minority participation percentage goals were attained; however, the Contractor did not meet the 6.90% Female Participation goal at 2.57%.

CNG Emergency Generator Division 7 and 8
Prime: Taft Electric

The CNG Emergency Generator Division 7 and 8 project is 100% complete as of May 2015. Final reporting shows the Targeted Worker attainment at 46.42%, Apprentice Worker attainment at 25.51%, Disadvantaged Worker attainment at 39.08% and the minority percentage goals were attained; however, the Contractor did not meet the 6.90% Female Participation goal at 4.68%. The attainment for the 20% Apprentice worker goal is based on total apprenticeable hours. No labor grievances occurred on this project.

Division 13 CNG Fueling Facility, Design/Build/Operate
Prime: Clean Energy

The Division 13 CNG Fueling Facility, Design/Build/Operate project Contractor is 100% complete as of June 2015. Final reporting shows the Targeted Worker attainment at 67.54%, Apprentice Worker attainment at 20.17%, Disadvantaged Worker attainment at 60.72% and the minority percentage goals were attained; however, the Contractor did not meet the 6.90% Female Participation goal at 1.69%. The attainment for the 20% Apprentice worker goal is based on total apprenticeable hours. No labor grievances occurred on this project.

Metro Blue Line Station Refurbishments
Prime: S.J. Amoroso

The Metro Blue Line Station Refurbishments project Contractor is 100% complete as of August 2015. Final reporting shows the Targeted Worker attainment at 56.01%, Apprentice Worker attainment at 26.10%, Disadvantaged Worker attainment at 13.62% and the minority percentage goals were attained; however, the Contractor did not meet the 6.90% Female Participation goal at 0.48%. The attainment for the 20% Apprentice Worker goal is based on total apprenticeable hours.

Westside Subway Extension Advanced Utility Relocation (Fairfax Station)
Prime: W.A. Rasic

The Westside Subway Extension Advanced Utility Relocation – Fairfax Station project is 100% complete as of December 2015. Final reporting shows the Targeted Worker attainment at 63.27%, Apprentice Worker attainment at 20.61%, Disadvantaged Worker attainment at 19.90% and the minority percentage goals were attained; however, the Contractor did not meet the 6.90% Female Participation goal at 2.78%. The attainment for the 20% Apprentice Worker goal is based on total apprenticeable hours.

Metro Rail Security Kiosks
Prime: Icon-West

The Metro Rail Security Kiosks project is 100% complete as of March 2016. Final reporting shows the Targeted Worker attainment at 45.90%, Apprentice Worker attainment at 27.06%, Disadvantaged Worker attainment at 20.17% and the minority percentage goals were attained; however, the Contractor did not meet the 6.90% Female Participation goal at 0.00%. The attainment for the 20% Apprentice Worker goal is based on total apprenticeable hours. No labor grievances occurred on this project.

Westside Extension Project Advanced Utility Relocation (La Cienega)
Prime: Bubalo Construction

The Westside Extension Project Advanced Utility Relocation project is 100% completed as of October 2016. Final reporting shows the Targeted Worker attainment at 65.15%, Apprentice Worker attainment at 21.76%, Disadvantaged Worker attainment at 20.96% and the minority percentage goals were attained; however, the Contractor did not meet the 6.90% Female Participation goal at 0.57%. The attainment for the 20% Apprentice Worker goal is based on total apprenticeable hours. No labor grievances occurred on this project.

Metro Red Line/Metro Orange Line (MRL/MOL) North Hollywood Station West Entrance
Prime: Skanska

The Metro Red Line/Metro Orange Line (MRL/MOL) North Hollywood Station West Entrance project is 100% completed as of November 2016. Final reporting shows the Targeted Worker attainment at 57.79%, Apprentice Worker attainment at 24.28%, Disadvantaged Worker attainment at 15.78%, Female Participation goal at 7.44% and the minority percentage goals were attained. The attainment for the 20% Apprentice Worker goal is based on total apprenticeable hours.

Patsaouras Plaza POV Relocation, Pavers and Storm Drain Repairs
Prime: AP Construction

The Patsaouras Plaza Privately-Owned-Vehicle Relocation, Pavers and Storm Drain Repairs project is 100% completed as of April 2017. Final reporting shows the Targeted Worker attainment at 76.46%, Apprentice Worker attainment at 21.26%, Disadvantaged Worker attainment at 42.56% and the minority percentage goals were attained; however, the Contractor did not meet the 6.90% Female Participation goal at 3.91%. The attainment for the 20% Apprentice Worker goal is based on total apprenticeable hours. No labor grievances occurred on this project.

Universal City Pedestrian Bridge
Prime: Griffith Company

The Universal City Pedestrian Bridge project is 100% completed as of June 2017. Final reporting shows the Apprentice Worker attainment at 27.49%, Disadvantaged Worker goal at 12.55% and the minority participation percentage goals were attained; however, the Contractor did not meet the 40% Targeted Worker goal at 38.33% and the 6.90% Female Participation goal at 1.57%. The attainment for the 20% Apprentice Worker goal is based on total apprenticeable hours. Staff executed liquidated damages for not meeting the Targeted Worker goal for this project. The assessed liquidated damages were utilized during negotiations to offset the contractor's claimed additional costs and this issue is closed.

MRL Pershing Square Canopy Addition and Escalator Replacement
Prime: Clark Construction, LLP

The MRL Pershing Square Canopy Addition and Escalator Replacement project Contractor is 100% completed as of August 2017. Final reporting shows the Targeted Worker attainment at 50.62%, Apprentice Worker attainment at 33.68%, Disadvantaged Worker attainment at 14.12% and the minority percentage goals were attained; however, the Contractor did not meet the 6.90% Female Participation goal at 1.46%. The attainment for the 20% Apprentice Worker goal is based on total apprenticeable hours. No labor grievances occurred on this project.

Bob Hope Airport/Hollywood Way Station
Prime: CA Rasmussen

The Bob Hope Airport/Hollywood Way Station project is 100% completed as of April 2018. Final reporting shows the Targeted Worker attainment at 42.77%, the Apprentice Worker attainment at 22.62%, Disadvantaged Worker attainment at 12.71% and the minority percentage goals were attained; however, the Contractor did not meet the 6.90% Female Participation goal at 0.80%. The attainment for the 20% Apprentice Worker goal is based on total apprenticeable hours. No labor grievances occurred on this project.

Non-Revenue Maintenance Building at Vernon Yard
Prime: Access Pacific Inc.

The Non-Revenue Maintenance Building at Vernon Yard project is 100% completed as of May 2018. Final reporting shows the Targeted Worker attainment at 54.16%, the Apprentice Worker attainment at 20.90%, Disadvantaged Worker attainment at 12.93%, Female Participation goal at 7.64% and the minority percentage goals were attained. The attainment for the 20% Apprentice Worker goal is based on total apprenticeable hours.

Metro Blue Line Pedestrian & Swing Gates Installation
Prime: Icon West

The Metro Blue Line Pedestrian & Swing Gates Installation project is 100% completed as of July 2018. Final reporting shows the Targeted Worker attainment at 65.33%, the Apprentice Worker attainment at 25.61%, Disadvantaged Worker attainment at 11.56%, Female Participation goal at 1.02% and the minority percentage goals were attained. The attainment for the 20% Apprentice Worker goal is based on total apprenticeable hours.

ATTACHMENT B

Project Labor Agreement (PLA) / Construction Careers Policy (CCP) Update

**Report Data Through
December 2018 Reporting Period**

Crenshaw/LAX Transit Corridor Project

PLA Targeted Worker Attainment: Prime: Walsh/Shea

Report Data Through December 2018

No. of Work Hours*	Targeted Economically Disadvantaged Worker Utilization (%) Goal: 40%	Apprentice Utilization (%) Goal: 20%	Disadvantaged Worker Utilization (%) Goal: 10%
6,040,427.43	60.22%	23.22% Based on Total Apprenticiable Work Hours	12.23%

Percentage Project Complete Based on Worker Hours: 91.79% (rounded)

Executive Order 11246 Demographic Summary

No. of Work Hours*	African American Utilization	Asian/Pacific Islander Utilization	Caucasian Utilization	Hispanic Utilization	Native American Utilization	Other/Declined to state	Minority Utilization Goal: 28.3% (rounded)	Female Utilization Goal: 6.9%
6,040,427.43	11.85%	1.25%	21.27%	62.65%	1.03%	1.94%	76.78%	3.71%



*Cumulative Hours Through End of Noted Reporting Period – as Reported by Prime Contractor. Data subject to change to reflect updates or audits.

Regional Connector Transit Corridor Project

PLA Targeted Worker Attainment: Prime: R.C.C., Joint Venture

Report Data Through December 2018

No. of Work Hours*	Targeted Economically Disadvantaged Worker Utilization (%) Goal: 40%	Apprentice Utilization (%) Goal: 20%	Disadvantaged Worker Utilization (%) Goal: 10%
1,728,101.85	58.89%	16.09% Based on Total Apprenticesable Work Hours	9.00%

Percentage Project Complete Based on Worker Hours: 52.61% (rounded)

Executive Order 11246 Demographic Summary

No. of Work Hours*	African American Utilization	Asian/Pacific Islander Utilization	Caucasian Utilization	Hispanic Utilization	Native American Utilization	Other/Declined to state	Minority Utilization Goal: 28.3% (rounded)	Female Utilization Goal: 6.9%
1,728,101.85	7.19%	0.66%	25.87%	59.90%	0.82%	5.55%	68.57%	3.26%



*Cumulative Hours Through End of Noted Reporting Period – as Reported by Prime Contractor. Data subject to change to reflect updates or audits.

Westside Subway Extension Project, Section 1 – D/B

PLA Targeted Worker Attainment: Prime: S.T.S., Joint Venture

Report Data Through December 2018

No. of Work Hours*	Targeted Economically Disadvantaged Worker Utilization (%) Goal: 40%	Apprentice Utilization (%) Goal: 20%	Disadvantaged Worker Utilization (%) Goal: 10%
1,519,264.99	64.19%	17.54% Based on Total Apprenticeship Work Hours	10.40%

Percentage Project Complete Based on Worker Hours: 46.65%(rounded)

Executive Order 11246 Demographic Summary

No. of Work Hours*	African American Utilization	Asian/Pacific Islander Utilization	Caucasian Utilization	Hispanic Utilization	Native American Utilization	Other/ Declined to state	Minority Utilization Goal: 28.3% (rounded)	Female Utilization Goal: 6.9%
1,519,264.99	11.01%	1.75%	21.39%	61.28%	0.35%	4.22%	74.39%	4.04%



*Cumulative Hours Through End of Noted Reporting Period – as Reported by Prime Contractor. Data subject to change to reflect updates or audits.

Division 16: Southwestern Yard

PLA Targeted Worker Attainment: Prime: Hensel Phelps/Herzog, JV

Report Data Through December 2018

No. of Work Hours*	Local Targeted Economically Disadvantaged Worker Utilization(%) Goal: 40%	Apprentice Utilization (%) Goal: 20%	Disadvantaged Worker Utilization (%) Goal: 10%
582,142.82	49.26%	29.25% Based on Total Apprenticesable Work Hours	10.25%

Percentage Project Complete Based on Worker Hours: 97.07% (rounded)

Executive Order 11246 Demographic Summary

No. of Work Hours*	African American Utilization	Asian/Pacific Islander Utilization	Caucasian Utilization	Hispanic Utilization	Native American Utilization	Other/Declined to state	Minority Utilization Goal: 28.3% (rounded)	Female Utilization Goal: 6.9%
582,142.82	6.29%	1.23%	19.18%	53.24%	0.20%	19.86%	60.96%	4.01%



*Cumulative Hours Through End of Noted Reporting Period – as Reported by Prime Contractor. Data subject to change to reflect updates or audits.

Patsaouras Plaza Busway Station

PLA Targeted Worker Attainment: Prime: OHL-USA, Inc.

Report Data Through December 2018

No. of Work Hours*	Targeted Economically Disadvantaged Worker Utilization (%) Goal: 40%	Apprentice Utilization (%) Goal: 20%	Disadvantaged Worker Utilization (%) Goal: 10%
70,843.75	57.36%	12.58% <small>Based on Total Apprenticesable Work Hours</small>	4.08%

Percentage Project Complete Based on Worker Hours: 83.35% (rounded)

Executive Order 11246 Demographic Summary

No. of Work Hours*	African American Utilization	Asian/Pacific Islander Utilization	Caucasian Utilization	Hispanic Utilization	Native American Utilization	Other/Declined to state	Minority Utilization Goal: 28.3% (rounded)	Female Utilization Goal: 6.9%
70,843.75	1.24%	3.06%	16.84%	74.11%	0.23%	4.52%	78.64%	1.22%



*Cumulative Hours Through End of Noted Reporting Period – as Reported by Prime Contractor. Data subject to change to reflect updates or audits.

Design Build – Maintenance of Way Bldg. 61S

PLA Targeted Worker Attainment: Prime: Clark Construction, Inc.

Report Data Through December 2018

No. of Work Hours*	Targeted Economically Disadvantaged Worker Utilization (%) Goal: 40%	Apprentice Utilization (%) Goal: 20%	Disadvantaged Worker Utilization (%) Goal: 10%
158,068.57	62.82%	25.28% <small>Based on Total Apprenticesable Work Hours</small>	11.72%

Percentage Project Complete Based on Worker Hours: 92.98% (rounded)

Executive Order 11246 Demographic Summary

No. of Work Hours*	African American Utilization	Asian/Pacific Islander Utilization	Caucasian Utilization	Hispanic Utilization	Native American Utilization	Other/Declined to state	Minority Utilization Goal: 28.3% (rounded)	Female Utilization Goal: 6.9%
158,068.57	1.55%	1.32%	17.33%	61.44%	0.09%	18.26%	64.40%	0.65%



*Cumulative Hours Through End of Noted Reporting Period – as Reported by Prime Contractor. Data subject to change to reflect updates or audits.

Division 1 Maintenance Annex Bldg.

PLA Targeted Worker Attainment: Prime: Metro Builders, Inc.

Report Data Through December 2018

No. of Work Hours*	Targeted Economically Disadvantaged Worker Utilization (%) Goal: 40%	Apprentice Utilization (%) Goal: 20%	Disadvantaged Worker Utilization (%) Goal: 10%
17,054.00	43.70%	19.98% <small>Based on Total Apprenticesable Work Hours</small>	14.29%

Percentage Project Complete Based on Worker Hours: 84.64% (rounded)

Executive Order 11246 Demographic Summary

No. of Work Hours*	African American Utilization	Asian/Pacific Islander Utilization	Caucasian Utilization	Hispanic Utilization	Native American Utilization	Other/Declined to state	Minority Utilization Goal: 28.3% (rounded)	Female Utilization Goal: 6.9%
17,054.00	4.88%	0.81%	2.43%	78.62%	0.00%	13.26%	84.31%	5.49%



*Cumulative Hours Through End of Noted Reporting Period – as Reported by Prime Contractor. Data subject to change to reflect updates or audits.

Division 9 Maintenance Annex Bldg.

PLA Targeted Worker Attainment: Prime: Metro Builders, Inc.

Report Data Through December 2018

No. of Work Hours*	Targeted Economically Disadvantaged Worker Utilization (%) Goal: 40%	Apprentice Utilization (%) Goal: 20%	Disadvantaged Worker Utilization (%) Goal: 10%
18,099.99	43.63%	26.85% <small>Based on Total Apprenticesable Work Hours</small>	9.43%

Percentage Project Complete Based on Worker Hours: 98.91% (rounded)

Executive Order 11246 Demographic Summary

No. of Work Hours*	African American Utilization	Asian/Pacific Islander Utilization	Caucasian Utilization	Hispanic Utilization	Native American Utilization	Other/Declined to state	Minority Utilization Goal: 28.3% (rounded)	Female Utilization Goal: 6.9%
18,099.99	4.38%	0.49%	11.97%	66.36%	0.00%	16.81%	71.23%	1.07%



*Cumulative Hours Through End of Noted Reporting Period – as Reported by Prime Contractor. Data subject to change to reflect updates or audits.

Westside Purple Line Ext. Sec 3 – Advanced Utility Rel PLA Targeted Worker Attainment: Prime: Bubalo Construction Co.

Report Data Through December 2018

No. of Work Hours*	Targeted Economically Disadvantaged Worker Utilization (%) Goal: 40%	Apprentice Utilization (%) Goal: 20%	Disadvantaged Worker Utilization (%) Goal: 10%
23,336.05	46.66%	21.15% <small>Based on Total Apprenticesable Work Hours</small>	11.20%

Percentage Project Complete Based on Worker Hours: 86.43% (rounded)

Executive Order 11246 Demographic Summary

No. of Work Hours*	African American Utilization	Asian/Pacific Islander Utilization	Caucasian Utilization	Hispanic Utilization	Native American Utilization	Other/Declined to state	Minority Utilization Goal: 28.3% (rounded)	Female Utilization Goal: 6.9%
23,336.05	0.27%	1.31%	8.72%	88.87%	0.00%	0.83%	90.45%	4.04%



*Cumulative Hours Through End of Noted Reporting Period – as Reported by Prime Contractor. Data subject to change to reflect updates or audits.

Metro Blue Line Signal System (Rehabilitation)

PLA Targeted Worker Attainment: Prime: Mass Electric Construction

Report Data Through December 2018

No. of Work Hours*	Targeted Economically Disadvantaged Worker Utilization (%) Goal: 40%	Apprentice Utilization (%) Goal: 20%	Disadvantaged Worker Utilization (%) Goal: 10%
6,855.00	14.87%	12.66% <small>Based on Total Apprenticesable Work Hours</small>	2.50%

Percentage Project Complete Based on Worker Hours: 14.21% (rounded)

Executive Order 11246 Demographic Summary

No. of Work Hours*	African American Utilization	Asian/Pacific Islander Utilization	Caucasian Utilization	Hispanic Utilization	Native American Utilization	Other/Declined to state	Minority Utilization Goal: 28.3% (rounded)	Female Utilization Goal: 6.9%
6,855.00	1.49%	1.05%	31.33%	50.87%	2.95%	12.32%	56.36%	0.00%



*Cumulative Hours Through End of Noted Reporting Period – as Reported by Prime Contractor. Data subject to change to reflect updates or audits.

Soundwall # 11 Construction

PLA Targeted Worker Attainment: Prime: Powell Constructors, Inc.

Report Data Through December 2018

No. of Work Hours*	Targeted Economically Disadvantaged Worker Utilization (%) Goal: 40%	Apprentice Utilization (%) Goal: 20%	Disadvantaged Worker Utilization (%) Goal: 10%
39,498.93	32.59%	10.66% <small>Based on Total Apprenticesable Work Hours</small>	0.21%

Percentage Project Complete Based on Worker Hours: 12.85% (rounded)

Executive Order 11246 Demographic Summary

No. of Work Hours*	African American Utilization	Asian/Pacific Islander Utilization	Caucasian Utilization	Hispanic Utilization	Native American Utilization	Other/Declined to state	Minority Utilization Goal: 28.3% (rounded)	Female Utilization Goal: 6.9%
39,498.93	4.84%	0.00%	10.97%	79.42%	0.02%	4.75%	84.28%	0.02%



*Cumulative Hours Through End of Noted Reporting Period – as Reported by Prime Contractor. Data subject to change to reflect updates or audits.

Willowbrooks/Rosa Parks Station Improvements

PLA Targeted Worker Attainment: Prime: Icon-West, Inc.

Report Data Through December 2018

No. of Work Hours*	Targeted Economically Disadvantaged Worker Utilization (%) Goal: 40%	Apprentice Utilization (%) Goal: 20%	Disadvantaged Worker Utilization (%) Goal: 10%
5,527.04	63.10%	19.00% <small>Based on Total Apprenticesable Work Hours</small>	0.00%

Percentage Project Complete Based on Worker Hours: 9.85% (rounded)

Executive Order 11246 Demographic Summary

No. of Work Hours*	African American Utilization	Asian/Pacific Islander Utilization	Caucasian Utilization	Hispanic Utilization	Native American Utilization	Other/Declined to state	Minority Utilization Goal: 28.3% (rounded)	Female Utilization Goal: 6.9%
5,527.04	6.35%	1.28%	23.30%	66.78%	0.00%	2.28%	74.41%	0.00%



*Cumulative Hours Through End of Noted Reporting Period – as Reported by Prime Contractor. Data subject to change to reflect updates or audits.

Crenshaw/LAX Advanced Utilities Relocations

PLA Targeted Worker Attainment: Prime: Metrobuilders

Report Data Through Oct 31, 2014 **(FINAL)**

No. of Work Hours	Targeted Economically Disadvantaged Worker Utilization (%) Goal: 40%	Apprentice Utilization (%) Goal: 20%	Disadvantaged Worker Utilization (%) Goal: 10%
61,708.26*	61.41%		21.08%
43,277.52**		13.84%	

Percentage Project Complete Based on Worker Hours: 100%

Executive Order 11246 Demographic Summary

No. of Work Hours*	African American Utilization	Asian/Pacific Islander Utilization	Caucasian Utilization	Hispanic Utilization	Native American Utilization	Other/Declined to state	Minority Utilization Goal: 28.3% (rounded)	Female Utilization Goal: 6.9%
61,708.26	11.66%	0.01%	22.02%	66.29%	0.01%	0.00%	77.97%	0.52%



* Total Cumulative Project Hours as Reported by Prime Contractor.

** Total Apprenticeable Cumulative Hours as Reported by Prime Contractor.

Westside Subway Extension Advanced Utilities

PLA Targeted Worker Attainment: Prime: Metrobuilders

Report Data Through November 2014 **(FINAL)**

No. of Work Hours*	Targeted Economically Disadvantaged Worker Utilization (%) Goal: 40%	Apprentice Utilization (%) Goal: 20%	Disadvantaged Worker Utilization (%) Goal: 10%
37,731.76	67.47%	11.12%	11.08%

Percentage Project Complete Based on Worker Hours: 100%

Executive Order 11246 Demographic Summary

No. of Work Hours*	African American Utilization	Asian/Pacific Islander Utilization	Caucasian Utilization	Hispanic Utilization	Native American Utilization	Other/Declined to state	Minority Utilization Goal: 28.3% (rounded)	Female Utilization Goal: 6.9%
37,731.76	3.92%	0.00%	12.76%	76.87%	0.00%	6.45%	80.79%	7.48%



*Cumulative Hours Through End of Noted Reporting Period – as Reported by Prime Contractor. Data subject to change to reflect updates or audits.

Westside Subway Extension Exploratory Shaft

PLA Targeted Worker Attainment: Prime: Innovative Constructive Solutions

Report Data Through October 2014 **(FINAL)**

No. of Work Hours	Targeted Economically Disadvantaged Worker Utilization (%) Goal: 40%	Apprentice Utilization (%) Goal: 20%	Disadvantaged Worker Utilization (%) Goal: 10%
*18,049.25	50.88%		11.23%
**238.50		75.05%	

Percentage Project Complete Based on Worker Hours: 100%

Executive Order 11246 Demographic Summary

No. of Work Hours*	African American Utilization	Asian/Pacific Islander Utilization	Caucasian Utilization	Hispanic Utilization	Native American Utilization	Other/Declined to state	Minority Utilization Goal: 28.3% (rounded)	Female Utilization Goal: 6.9%
18,049.25	11.40%	0.00%	22.71%	33.18%	1.19%	31.52%	45.77%	0.42%



* Total Cumulative Project Hours as Reported by Prime Contractor.

** Total Apprenticeable Cumulative Hours as Reported by Prime Contractor.

Regional Connector Advanced Utility Relocations

PLA Targeted Worker Attainment: Prime: Pulice

Report Data Through May 2015 **(FINAL)**

No. of Work Hours*	Targeted Economically Disadvantaged Worker Utilization (%) Goal: 40%	Apprentice Utilization (%) Goal: 20%	Disadvantaged Worker Utilization (%) Goal: 10%
58,903.00	51.61%	21.37% Contractor Reported Based on Total Work Hours	22.83%

Percentage Project Complete Based on Worker Hours: 100.00% (rounded)

Executive Order 11246 Demographic Summary

No. of Work Hours*	African American Utilization	Asian/Pacific Islander Utilization	Caucasian Utilization	Hispanic Utilization	Native American Utilization	Other/Declined to state	Minority Utilization Goal: 28.3% (rounded)	Female Utilization Goal: 6.9%
58,903.00	1.36%	0.41%	17.43%	80.30%	0.00%	0.50%	82.07%	2.57%



*Cumulative Hours Through End of Noted Reporting Period – as Reported by Prime Contractor. Data subject to change to reflect updates or audits.

CNG Emergency Generator Division 7 and 8

PLA Targeted Worker Attainment: Prime: Taft Electric Company

Report Data Through May 2015 **(FINAL)**

No. of Work Hours*	Targeted Economically Disadvantaged Worker Utilization (%) Goal: 40%	Apprentice Utilization (%) Goal: 20%	Disadvantaged Worker Utilization (%) Goal: 10%
3,289.50	46.42%	25.51% Based on Total Apprenticeable Work Hours	39.08%

Percentage Project Complete Based on Worker Hours: 100.00% (rounded)

Executive Order 11246 Demographic Summary

No. of Work Hours*	African American Utilization	Asian/Pacific Islander Utilization	Caucasian Utilization	Hispanic Utilization	Native American Utilization	Other/Declined to state	Minority Utilization Goal: 28.3% (rounded)	Female Utilization Goal: 6.9%
3,289.50	14.47%	1.92%	38.21%	45.40%	0.00%	0.00%	61.79%	4.68%



*Cumulative Hours Through End of Noted Reporting Period – as Reported by Prime Contractor. Data subject to change to reflect updates or audits.

Division 13 CNG Fueling Facility, Design/Build/Operate

PLA Targeted Worker Attainment: Prime: Clean Energy

Report Data Through June 2015 **(FINAL)**

No. of Work Hours*	Targeted Economically Disadvantaged Worker Utilization (%) Goal: 40%	Apprentice Utilization (%) Goal: 20%	Disadvantaged Worker Utilization (%) Goal: 10%
11,496.00	67.54%	20.17% <small>Based on Total Apprenticeshipable Work Hours</small>	60.72%

Percentage Project Complete Based on Worker Hours: 100.00% (rounded)

Executive Order 11246 Demographic Summary

No. of Work Hours*	African American Utilization	Asian/Pacific Islander Utilization	Caucasian Utilization	Hispanic Utilization	Native American Utilization	Other/Declined to state	Minority Utilization Goal: 28.3% (rounded)	Female Utilization Goal: 6.9%
11,496.00	31.21%	3.03%	26.54%	39.23%	0.00%	0.00%	73.47%	1.69%



*Cumulative Hours Through End of Noted Reporting Period – as Reported by Prime Contractor. Data subject to change to reflect updates or audits.

Metro Blue Line Station Refurbishments

PLA Targeted Worker Attainment: Prime: S.J. Amoroso

Report Data Through June 2015 (FINAL)

No. of Work Hours*	Targeted Economically Disadvantaged Worker Utilization (%) Goal: 40%	Apprentice Utilization (%) Goal: 20%	Disadvantaged Worker Utilization (%) Goal: 10%
41,274.75	56.01%	26.10% Based on Total Apprenticesable Work Hours	13.62%

Percentage Project Complete Based on Worker Hours: 100.00% (rounded)

Executive Order 11246 Demographic Summary

No. of Work Hours*	African American Utilization	Asian/Pacific Islander Utilization	Caucasian Utilization	Hispanic Utilization	Native American Utilization	Other/Declined to state	Minority Utilization Goal: 28.3% (rounded)	Female Utilization Goal: 6.9%
41,274.75	16.59%	1.55%	20.72%	61.14%	0.00%	0.00%	79.28%	0.48%



*Cumulative Hours Through End of Noted Reporting Period – as Reported by Prime Contractor. Data subject to change to reflect updates or audits.

Westside Subway Extension Project AUR (Fairfax Station)

PLA Targeted Worker Attainment: Prime: W.A. Rasic

Report Data Through December 2015 (FINAL)

No. of Work Hours*	Targeted Economically Disadvantaged Worker Utilization (%) Goal: 40%	Apprentice Utilization (%) Goal: 20%	Disadvantaged Worker Utilization (%) Goal: 10%
37,510.00	63.27%	20.61% <small>Based on Total Apprenticesable Work Hours</small>	19.90%

Percentage Project Complete Based on Worker Hours: 100.00% (rounded)

Executive Order 11246 Demographic Summary

No. of Work Hours*	African American Utilization	Asian/Pacific Islander Utilization	Caucasian Utilization	Hispanic Utilization	Native American Utilization	Other/Declined to state	Minority Utilization Goal: 28.3% (rounded)	Female Utilization Goal: 6.9%
37,510.00	9.44%	0.01%	13.39%	77.08%	0.00%	0.09%	86.53%	2.78%



*Cumulative Hours Through End of Noted Reporting Period – as Reported by Prime Contractor. Data subject to change to reflect updates or audits.

Metro Rail Security Kiosks

PLA Targeted Worker Attainment: Prime: Icon-West

Report Data Through March 2016 (FINAL)

No. of Work Hours*	Targeted Economically Disadvantaged Worker Utilization (%) Goal: 40%	Apprentice Utilization (%) Goal: 20%	Disadvantaged Worker Utilization (%) Goal: 10%
7,281.75	45.90%	27.06% <small>Based on Total Apprenticesable Work Hours</small>	20.17%

Percentage Project Complete Based on Worker Hours: 100.00% (rounded)

Executive Order 11246 Demographic Summary

No. of Work Hours*	African American Utilization	Asian/Pacific Islander Utilization	Caucasian Utilization	Hispanic Utilization	Native American Utilization	Other/Declined to state	Minority Utilization Goal: 28.3% (rounded)	Female Utilization Goal: 6.9%
7,281.75	48.19%	0.27%	15.16%	34.78%	0.87%	0.72%	84.11%	0.00%



*Cumulative Hours Through End of Noted Reporting Period – as Reported by Prime Contractor. Data subject to change to reflect updates or audits.

Westside Extension Project AUR (La Cienega Station)

PLA Targeted Worker Attainment: Prime: Bubalo Construction

Report Data Through October 2016 **(FINAL)**

No. of Work Hours*	Targeted Economically Disadvantaged Worker Utilization (%) Goal: 40%	Apprentice Utilization (%) Goal: 20%	Disadvantaged Worker Utilization (%) Goal: 10%
52,043.60	65.15%	21.76% <small>Based on Total Apprenticesable Work Hours</small>	20.96%

Percentage Project Complete Based on Worker Hours: 100% (rounded)

Executive Order 11246 Demographic Summary

No. of Work Hours*	African American Utilization	Asian/Pacific Islander Utilization	Caucasian Utilization	Hispanic Utilization	Native American Utilization	Other/Declined to state	Minority Utilization Goal: 28.3% (rounded)	Female Utilization Goal: 6.9%
52,043.60	4.84%	0.00%	7.52%	87.64%	0.00%	0.00%	92.48%	0.57%



*Cumulative Hours Through End of Noted Reporting Period – as Reported by Prime Contractor. Data subject to change to reflect updates or audits.

MRL/MOL North Hollywood Station West Entrance

PLA Targeted Worker Attainment: Prime: Skanska

Report Data Through November 2016 **(FINAL)**

No. of Work Hours*	Targeted Economically Disadvantaged Worker Utilization (%) Goal: 40%	Apprentice Utilization (%) Goal: 20%	Disadvantaged Worker Utilization (%) Goal: 10%
85,105.00	57.79%	24.28% <small>Based on Total Apprenticesable Work Hours</small>	15.78%

Percentage Project Complete Based on Worker Hours: 100% (rounded)

Executive Order 11246 Demographic Summary

No. of Work Hours*	African American Utilization	Asian/Pacific Islander Utilization	Caucasian Utilization	Hispanic Utilization	Native American Utilization	Other/Declined to state	Minority Utilization Goal: 28.3% (rounded)	Female Utilization Goal: 6.9%
85,105.00	11.06%	0.40%	27.47%	56.58%	1.04%	3.45%	69.08%	7.44%



*Cumulative Hours Through End of Noted Reporting Period – as Reported by Prime Contractor. Data subject to change to reflect updates or audits.

Patsaouras Plaza POV Relocation, Pavers & Storm Drain PLA Targeted Worker Attainment: Prime: AP Construction

Report Data Through April 2017 **(FINAL)**

No. of Work Hours*	Targeted Economically Disadvantaged Worker Utilization (%) Goal: 40%	Apprentice Utilization (%) Goal: 20%	Disadvantaged Worker Utilization (%) Goal: 10%
18,173.00	76.46%	21.26% <small>Based on Total Apprenticesable Work Hours</small>	42.56%

Percentage Project Complete Based on Worker Hours: 100% (rounded)

Executive Order 11246 Demographic Summary

No. of Work Hours*	African American Utilization	Asian/Pacific Islander Utilization	Caucasian Utilization	Hispanic Utilization	Native American Utilization	Other/Declined to state	Minority Utilization Goal: 28.3% (rounded)	Female Utilization Goal: 6.9%
18,173.00	6.96%	0.35%	3.31%	89.06%	0.00%	0.33%	96.37%	3.91%



*Cumulative Hours Through End of Noted Reporting Period – as Reported by Prime Contractor. Data subject to change to reflect updates or audits.

Universal City Pedestrian Bridge

PLA Targeted Worker Attainment: Prime: Griffith Company

Report Data Through June 2017 **(FINAL)**

No. of Work Hours*	Targeted Economically Disadvantaged Worker Utilization (%) Goal: 40%	Apprentice Utilization (%) Goal: 20%	Disadvantaged Worker Utilization (%) Goal: 10%
109,020.00	38.33%	27.49% <small>Based on total Apprenticeable Work hours</small>	12.55%

Percentage Project Complete Based on Worker Hours: 100% (rounded)

Executive Order 11246 Demographic Summary

No. of Work Hours*	African American Utilization	Asian/Pacific Islander Utilization	Caucasian Utilization	Hispanic Utilization	Native American Utilization	Other/ Declined to state	Minority Utilization Goal: 28.3% (rounded)	Female Utilization Goal: 6.9%
109,020.00	8.50%	4.11%	22.25%	61.79%	0.62%	2.83%	75.02%	1.57%



*Cumulative Hours Through End of Noted Reporting Period – as Reported by Prime Contractor. Data subject to change to reflect updates or audits.

MRL Pershing Square Canopy & Escalator Replacement

PLA Targeted Worker Attainment: Prime: Clark Construction, LLP

Report Data Through June 2017 (FINAL)

No. of Work Hours*	Targeted Economically Disadvantaged Worker Utilization (%) Goal: 40%	Apprentice Utilization (%) Goal: 20%	Disadvantaged Worker Utilization (%) Goal: 10%
22,562.00	50.62%	33.68% <small>Based on Total Apprenticesable Work Hours</small>	14.12%

Percentage Project Complete Based on Worker Hours: 100% (rounded)

Executive Order 11246 Demographic Summary

No. of Work Hours*	African American Utilization	Asian/Pacific Islander Utilization	Caucasian Utilization	Hispanic Utilization	Native American Utilization	Other/Declined to state	Minority Utilization Goal: 28.3% (rounded)	Female Utilization Goal: 6.9%
22,562.00	6.13%	1.91%	41.21%	46.93%	1.15%	2.67%	56.12%	1.46%



*Cumulative Hours Through End of Noted Reporting Period – as Reported by Prime Contractor. Data subject to change to reflect updates or audits.

Bob Hope Airport/Hollywood Way Station

PLA Targeted Worker Attainment: Prime: C.A. Rasmussen, Inc.

Report Data Through April 2018 (FINAL)

No. of Work Hours*	Targeted Economically Disadvantaged Worker Utilization (%) Goal: 40%	Apprentice Utilization (%) Goal: 20%	Disadvantaged Worker Utilization (%) Goal: 10%
21,378.00	42.77%	22.62% <small>Based on Total Apprenticesable Work Hours</small>	12.71%

Percentage Project Complete Based on Worker Hours: 100% (rounded)

Executive Order 11246 Demographic Summary

No. of Work Hours*	African American Utilization	Asian/Pacific Islander Utilization	Caucasian Utilization	Hispanic Utilization	Native American Utilization	Other/Declined to state	Minority Utilization Goal: 28.3% (rounded)	Female Utilization Goal: 6.9%
21,378.00	2.78%	0.13%	10.20%	73.09%	0.04%	13.75%	76.04%	0.80%



*Cumulative Hours Through End of Noted Reporting Period – as Reported by Prime Contractor. Data subject to change to reflect updates or audits.

Non-Revenue Maintenance Bldg. at Vernon Yard

PLA Targeted Worker Attainment: Prime: Access Pacific, Inc.

Report Data Through May 2018 (FINAL)

No. of Work Hours*	Targeted Economically Disadvantaged Worker Utilization (%) Goal: 40%	Apprentice Utilization (%) Goal: 20%	Disadvantaged Worker Utilization (%) Goal: 10%
12,350.00	54.16%	20.90% <small>Based on Total Apprenticesable Work Hours</small>	12.93%

Percentage Project Complete Based on Worker Hours: 100% (rounded)

Executive Order 11246 Demographic Summary

No. of Work Hours*	African American Utilization	Asian/Pacific Islander Utilization	Caucasian Utilization	Hispanic Utilization	Native American Utilization	Other/Declined to state	Minority Utilization Goal: 28.3% (rounded)	Female Utilization Goal: 6.9%
12,350.00	0.39%	0.22%	11.91%	82.01%	0.52%	4.96%	83.14%	7.64%



*Cumulative Hours Through End of Noted Reporting Period – as Reported by Prime Contractor. Data subject to change to reflect updates or audits.

Metro Blue Line Pedestrian & Swing Gates

PLA Targeted Worker Attainment: Prime: Icon-West

Report Data Through July 2018 (FINAL)

No. of Work Hours*	Targeted Economically Disadvantaged Worker Utilization (%) Goal: 40%	Apprentice Utilization (%) Goal: 20%	Disadvantaged Worker Utilization (%) Goal: 10%
62,860.00	65.33%	25.61% <small>Based on Total Apprenticeable Work Hours</small>	11.56%

Percentage Project Complete Based on Worker Hours: 100% (rounded)

Executive Order 11246 Demographic Summary

No. of Work Hours*	African American Utilization	Asian/Pacific Islander Utilization	Caucasian Utilization	Hispanic Utilization	Native American Utilization	Other/Declined to state	Minority Utilization Goal: 28.3% (rounded)	Female Utilization Goal: 6.9%
62,860.00	5.09%	0.02%	12.09%	76.59%	0.00%	5.07%	81.70%	1.02%



*Cumulative Hours Through End of Noted Reporting Period – as Reported by Prime Contractor. Data subject to change to reflect updates or audits.

EXHIBIT C
CONTRACTORS PLAN TO INCREASE FEMALE PARTICIPATION

Project Name:	Prime Contractor:	Action Plan to Increase Female Participation	Accomplishments
Crenshaw/LAX Transit Corridor	Walsh/Shea Corridor Constructors	<ul style="list-style-type: none"> • Continued collaboration with Community Based Organization in outreaching to female workers. • Targeted outreach • Collaborate with various unions 	Increased female participation attainment from 3.27% in September 2017 to 3.71% as of this reporting period. To date a total of 170 female workers hired on the project.
Regional Connector Transit Corridor	Regional Connector Constructors, JV	<ul style="list-style-type: none"> • Continued collaboration with Community Based Organization in outreaching to female workers • Targeted Outreach • Sponsor female workers into the unions 	Contractor has sponsored several females into the various union trades. To date a total of 74 female workers hired on the project.
Westside Subway Extension Project, Section 1 – D/B	Skanska-Traylor-Shea, JV	<ul style="list-style-type: none"> • Continued collaboration with Community Based Organization to outreach to female workers • Targeted Outreach • Sponsor female workers into the unions 	Contractor has sponsored several females into the various union trades. To date a total of 73 female workers hired on the project.
Division 16 Southwestern Yard	Hensel Phelps/Herzog, JV	<ul style="list-style-type: none"> • Targeted outreach to female workers • Sponsor female workers into the unions 	Contractor has hired additional 3 female workers as of this reporting period. Attained 4.01% female participation as of this reporting period. To date a total of 46 female workers hired on the project.
Patsaouras Plaza Busway Station	OHL-USA, Inc.	<ul style="list-style-type: none"> • Contractor to request female workers from the unions. • Targeted outreach to female workers 	Non-reported at this time, project on hold status.
New Maintenance of Way/Non Revenue Vehicle Building 61S	Clark Construction, Inc.	<ul style="list-style-type: none"> • Contractor to collaborate with WINTER to recruit female workers • Targeted outreach to female workers 	Contractor hired a female worker as of this reporting period, bringing a total of 9 female workers hired on the project.
Westside Purple Line Extension Project, Section 3 Advanced Utility Relocations	Bubalo Construction Co.	<ul style="list-style-type: none"> • Targeted Outreach • Sponsor female workers to the unions 	Contractor sponsored 2 female workers into the unions. Attained 4.04% female participation as of this reporting period.



Project Labor Agreement (PLA)/
Construction Careers Policy (CCP) Report
Construction Committee
March 21, 2019

PLA/CCP Program Achievements

- **Attainment - Program Inception to December 2018**
 - 59.63% Economically Disadvantaged
 - 21.61% Apprentice
 - 11.56% Disadvantaged
- >\$209 Million paid to Targeted Workers *
 - \$40 Million paid to Disadvantaged Workers *
 - \$56 Million paid to Apprentice Workers**
- Exceeded Targeted/Apprentice/Disadvantaged Worker Goals
- No work stoppages or lockouts

(*Based on the lowest laborers rate as of June 2017)

(**Based on the lowest apprentice rate as of January 2017)

(Workers may fall into multiple categories)



Female Participation Attainment

Female Participation Attainment

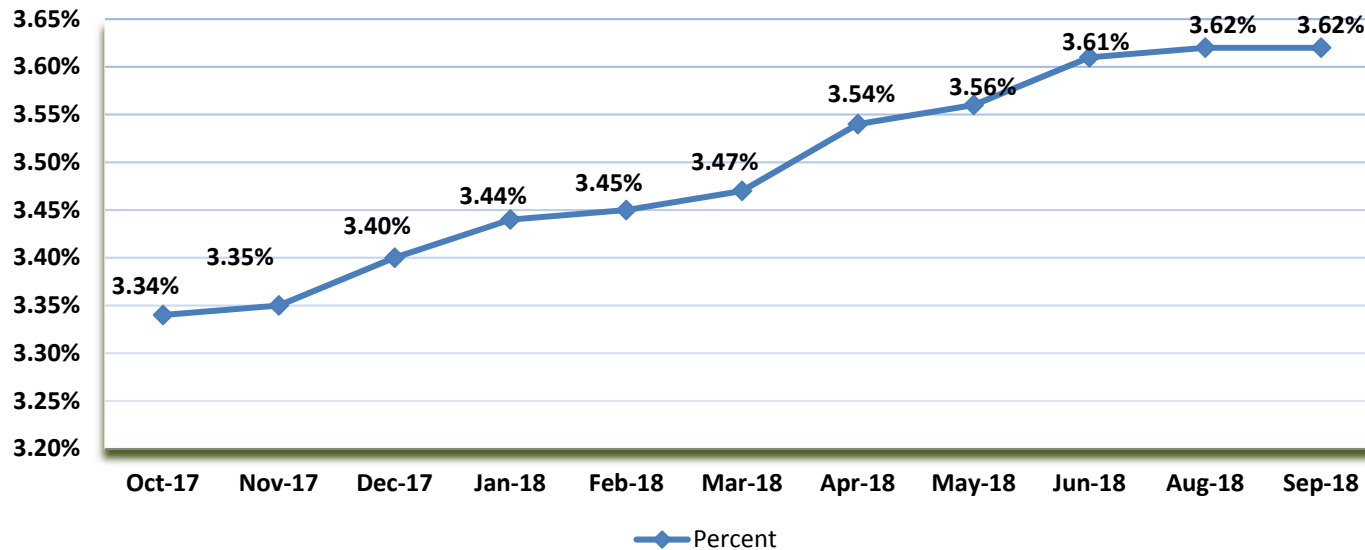

- Steady measurable increase of overall participation
- 385 female workers were hired on all active construction projects as of reporting period

Female Participation Score Card

- ❖ Overall female participation attainment is 3.62%
- ❖ Highest rating as of FY 19 Q2 reporting is B grade

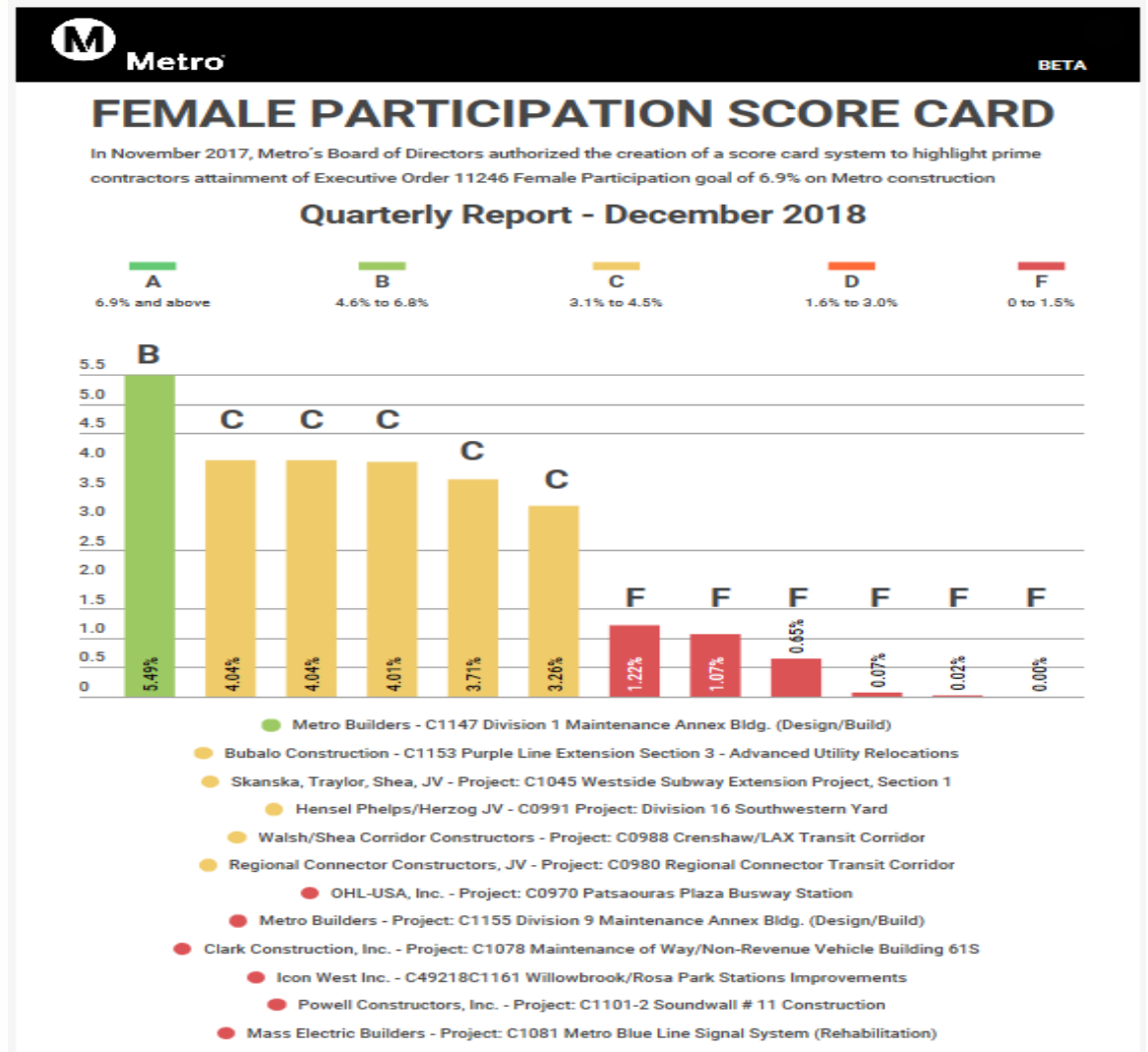



Women in the Trades Action Plan

- Initiated efforts to increase female participation attainment such as: female participation scorecard, quarterly meeting with prime contractor's job coordinators and increased female attainment compliance monitoring; including other initiatives
- Developed an action plan now rebranded as Women in the Trades Action Plan
- Developed Women in Trades Resources Guide
- Commissioned a Regional Construction Workforce Study to assess the current and future capacity of women in the trades



Metro

Women in the Trades Resource Guide

- ❖ Provide insights and best practices to contractors, job coordinators and workers
- ❖ Developed in collaboration with partners such as WINTER and others

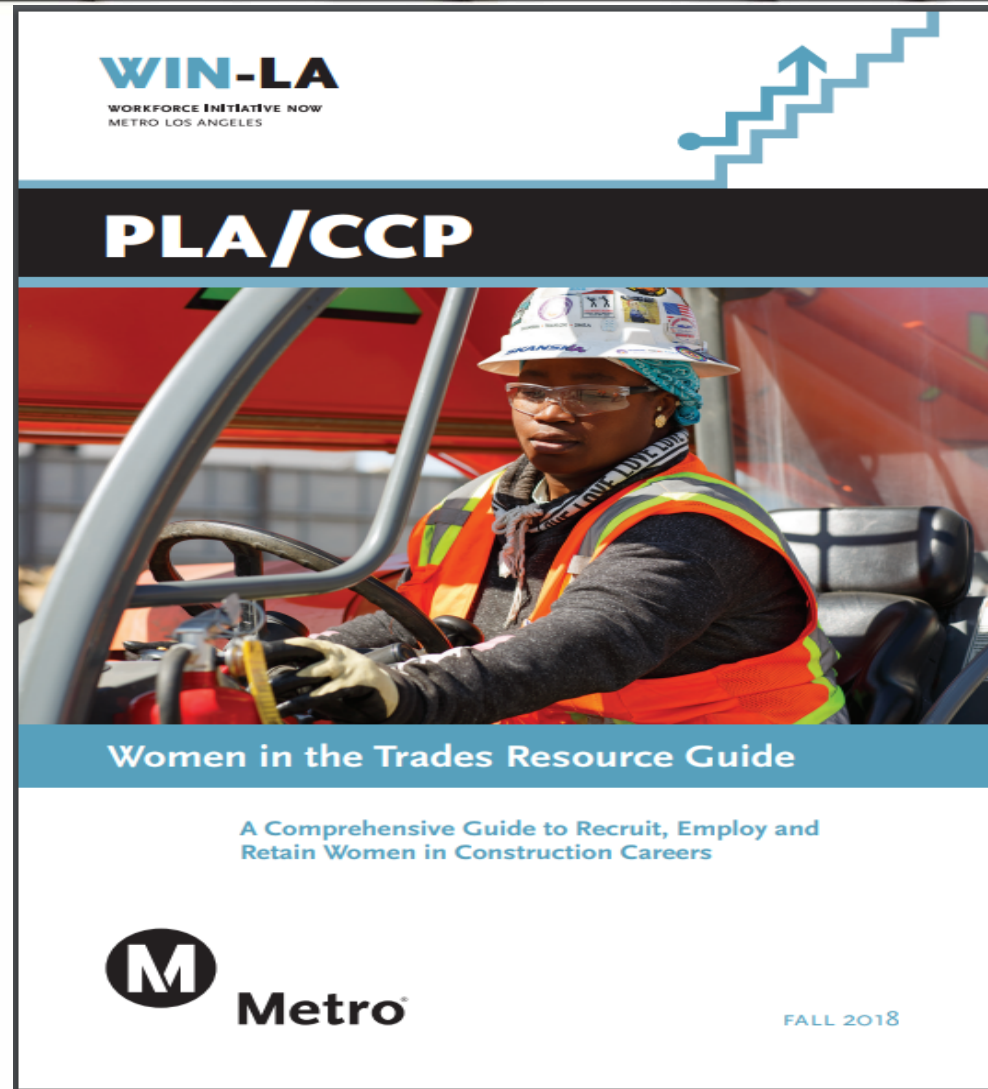

Female Worker Exit Interviews

Population 14 Females From Regional Connector Corridor Project

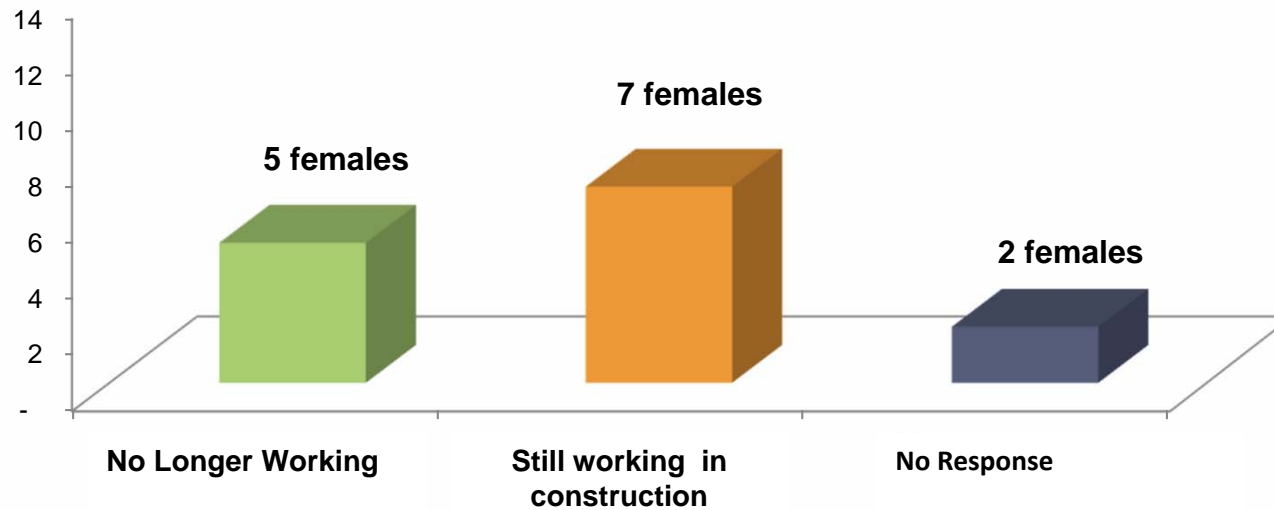

Female Worker Exit Interviews

5 Female Workers From Regional Connector Project No Longer Working

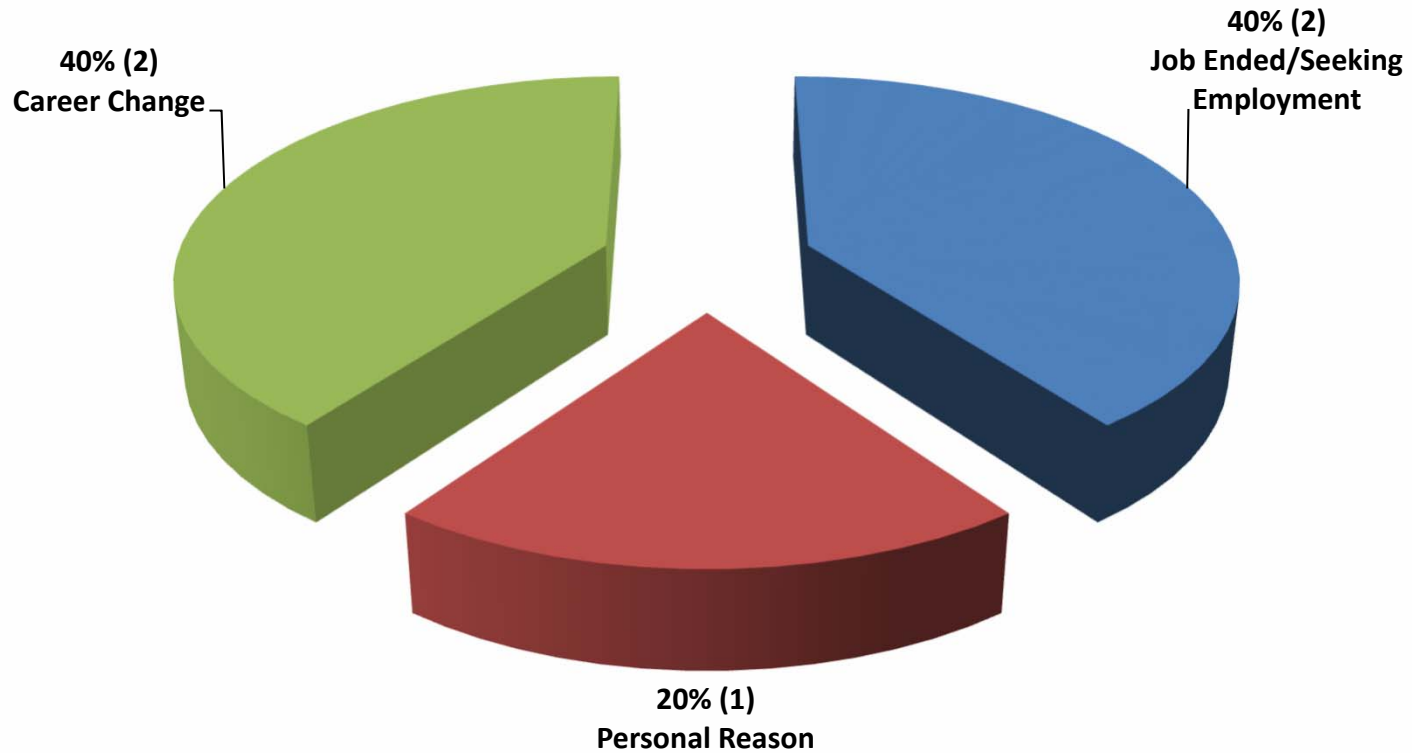

Outreach and Engagement Activities

- ❖ Ongoing focus on recruitment and retention of women on Metro projects
- ❖ Implement best practices and/or recommendations from Regional Construction Workforce Study
- ❖ Continue outreach and engagement activities
- ❖ “Women Build METRO LA” Apprenticeship Readiness Fair symposium on November 8, 2018 in 5th District
- ❖ “Women Build METRO LA” event May 17, 2019 at LA Metro





Thank you



Board Report

File #: 2019-0119, File Type: Contract

Agenda Number: 32.

REVISED
CONSTRUCTION COMMITTEE
MARCH 21, 2019

SUBJECT: METRO GOLD LINE INTERSTATE 210 BARRIER REPLACEMENT

ACTION: APPROVE RECOMMENDATIONS

RECOMMENDATION

CONSIDER:

- A. INCREASING Design Life-of-Project (LOP) Budget for Metro Gold Line Interstate 210 Barrier Replacement, (CP Number 405581) by \$11,463,026, increasing the LOP budget from \$11,078,366 to \$22,541,392; and
- B. AUTHORIZING the Chief Executive Officer to execute Contract Modification No. 1 to the On-Call Highway Program Project Delivery Support Services Contract Nos. AE30673000, AE30673001, AE30673002 with AECOM, CH2M Hill, and Parsons Transportation Group, respectively, in the amount not-to exceed \$11,000,000 increasing the total contract value from \$30,000,000 to \$41,000,000.

ISSUE

Since the opening of the Metro Gold Line, there have been ten accidents in which mostly high profile vehicles, traveling on the 210 Freeway, have entered into Metro's operating Right-of-Way. The latest incident occurred on Thursday, November 22, 2018. During the incident, a tractor trailer breached the existing concrete barrier causing damage to the Gold Line system and resulting in a major disruption. Staff has been working on developing a design for barrier improvements for the Pasadena Gold Line to effectively mitigate the risks of future breaches into Metro's Gold Line Right-of-Way. Once the barrier improvements design is completed and approved by Caltrans, Metro will procure a construction contract for installation of the improvements.

The Design LOP budget was approved at the May 2016 board for an amount of \$11,078,366. The original design contract was awarded to CH2M Hill Inc. (now a part of Jacobs) for an initial value of \$4,799,967. Two modifications to this contract were made that brought the total value of the contract

to \$5,233,277.

The environmental impact and disruption to Metro Gold Line operations during construction of this project are much larger than initially anticipated. To effectively address all the environmental issues and provide a complete design that accounts for Metro rail operation, an adjustment to the initial LOP funding needs to be made to cover the increased costs through final design.

BACKGROUND

The original project was initially scoped and considered as a relatively simple and straightforward barrier replacement project. It was assumed that this project would be easily cleared environmentally because all the anticipated work was going to be within the prism of the roadway on State or public right-of-way. Also, no significant impacts or resource agency permits were expected. However, as the design development phase proceeded, information from the field began to greatly complicate the project.

For the majority of the project limits, the tight spatial constraint of the project site will require the closure of the HOV lane on the I-210 freeway and single tracking of the Gold Line during the removal and replacement of the existing median barrier. The non-standard features of the existing freeway had to be reviewed and current mitigation measures needed to be reevaluated to determine if they were still effective. For example, some portions of the I-210 freeway currently do not meet the standard stopping site distance requirement. This non-standard feature is currently being mitigated by tail light requirements (a requirement that following vehicles can observe the tail lights on a preceding vehicle to ensure adequate braking distance). By increasing the height of the median barrier, the project would no longer meet the current tail light requirement and a new mitigation measure for stopping site distance must be studied and implemented. Also, the design was obliged to comply with some of the new code requirements and where possible add new features such as lighting at each HOV egress and ingress locations.

Since the HOV lane of the I-210 freeway will be closed for a significant length of time during construction of this project, traffic diverting from I-210 mainline onto local streets is expected. To better understand the traffic and environmental impacts imposed by this project, a specialized microsimulation traffic analysis and a focused air quality study during construction were added to the project's scope of work. The tight spatial constraints and the need to design the barriers for the highest crash worthiness required the development of more complicated non-standard barrier details which will require Caltrans' approval.

DISCUSSION

We have presented a Board Box dated November 16, 2018 detailing the project progress. In that progress report, we also outlined the next steps necessary to successfully complete the project.

There are various factors that contributed to contract changes and increased costs and the need to increase the design LOP. The project was initially scoped for somewhat simple barrier replacement. The scope of design and environmental studies were well coordinated with Caltrans prior to establishing a LOP.

Neither Metro nor Caltrans foresaw the environmental issues and design difficulties that the project is currently facing. These difficulties include, large freeway traffic disruptions during construction that give rise to delays beyond acceptable limits, resulting in diversion of traffic onto the local streets which causes issues with air quality and noise, addressing existing non-standard freeway features, obtaining approval for use of stronger non-standard barriers, and impacting Metro's operations during construction of the project.

Metro and Caltrans have agreed to divide the project into two pieces. This will allow the portion with lesser environmental issues to move forward at a faster pace towards final design while the environmental issues on the other portion are being addressed. Due to the urgency of the project, the design has been moving forward at risk, meaning that the environmental studies and the final design are being done concurrently. Therefore, now that the project is divided into two pieces, some of the work that has already been done needs to be revised, impacting the cost of the project.

Currently about \$3.9 million is still remaining from the original LOP. This contract was awarded to CH2M as an on-call contract (Contract No. PS4730-3070) and has since expired. No additional change orders can be issued to CH2M through this contract. Staff recommends utilizing the On-Call Highway Program Project Delivery Support Services contract (Contract No. AE30673001) approved by the Board on 06/27/2017. CH2M is one of the consultants that competed and was selected to perform engineering services under that contract. In order to be responsive to this high priority and urgent project and provide continuity to the project, we elected to use this Metro contract with CH2M to continue the design.

DETERMINATION OF SAFETY IMPACT

This Board's decision to approve this Project is paramount to ensuring public safety along the Metro Gold Line I-210 corridor.

Completion of this project will be an important step in improving safety and reducing the likelihood of future breaches into Metro's Gold Line Operational Right-of- Way. The improvements described in this project are necessary for public safety.

FINANCIAL IMPACT

The funds for FY19 is included in cost center 8510 - Construction Procurement, under project number 405581 - I-210 Barrier Replacement. Since this is a multi-year project, the Project Manager, the cost center manager and Chief Program Management Officer will be accountable for budgeting

the cost in future years.

Impact to Budget

The funding source for this action will come from Proposition C 25% (PC25%) as a result of work scope aligned with highway related improvements. This fund source is not eligible for operating or capital improvements on bus and rail. No other fund sources were considered.

IMPLEMENTATION OF STRATEGIC PLAN GOALS

By supporting the recommendation to increase the LOP budget of the I-210 Barrier Replacement Project, the Board is supporting Metro's strategic plan goal 1 which promotes trip reliability, reduces trip disruptions as well as delivery of world-class transit service by ensuring our transit assets are in a state of good repair. Each time the median barrier was breached, Metro's Gold Line operations and ridership were affected. The I-210 Barrier Replacement Project will eliminate the likelihood of a freeway vehicle breaching the median barrier and affecting Gold Line operations in the future.

ALTERNATIVES CONSIDERED

The following alternatives were considered:

1. Keeping the value of LOP at current level will not provide the necessary funds to complete the design of this project. The existing barrier, which does not prevent intrusion of high profile vehicles, will remain in place. This alternative is not recommended since, on an average basis, we experience two vehicle intrusions per year into Metro operating right of way.
2. Awarding the remaining portion of the work to a firm other than CH2M/Jacob or issuance of a new contract other than the Highway Program On-Call Services Contract. This will require procurement of a new contract. This alternative is not recommended because it will delay the project considerably either because of the time that it will take to procure a new contract or the time it would take for a new team to learn about the project before continuing with the current design.

NEXT STEPS

Upon Board approval, staff will execute Contract Modification No. 1 to the On-Call Highway Program Project Delivery Support Services contracts with CH2M Hill, AECOM and Parsons Transportation Group and issue a Task Order to CH2M Hill to continue design of the project and obtain Caltrans approval for the replacement the existing barrier along the median of I-210. Staff will report monthly project progress to the Board.

ATTACHMENTS

Attachment A - Procurement Summary
Attachment B - Contract Modification/Change Order Log
Attachment C - DEOD Summary
Attachment D - Funding/Expenditure Plan

Prepared by:

Androush Danielians, Executive Officer (213) 922-7598

Reviewed by:

Richard Clarke, Chief Program Management Officer (213) 922-7557
Debra Avila, Chief Vendor/Contract Management Officer (213) 418-3051

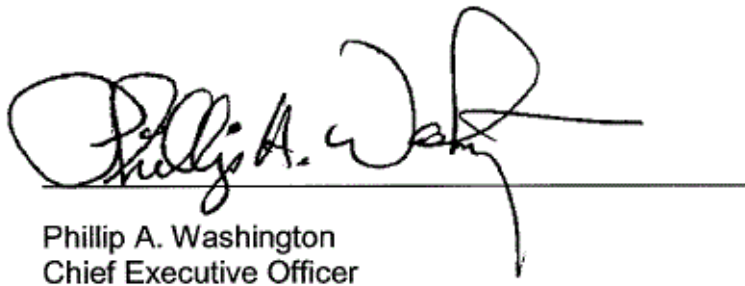

Phillip A. Washington
Chief Executive Officer

PROCUREMENT SUMMARY

ON-CALL HIGHWAY PROGRAM PROJECT DELIVERY SUPPORT SERVICES

AE30673000/AE30673001/AE30673002

1.	Contract Number: AE30673000/AE30673001/AE30673002		
2.	Contractor: AECOM, CH2M Hill Inc., Parsons Transportation Group		
3.	Mod. Work Description: Replace existing I-210 non-standard barriers with taller barriers capable to withstanding crash loads equivalent to TL-5 load rated barriers.		
4.	Contract Work Description: On-Call Highway Program Project Delivery Support Services		
5.	The following data is current as of: March 7, 2019		
6.	Contract Completion Status		Financial Status
	Contract Awarded:	June 27, 2017	Contract Award Amount: \$30,000,000
	Notice to Proceed (NTP):	N/A	Total of Modifications Approved: \$0.00
	Original Complete Date:	June 21, 2020	Pending Modifications (including this action): \$11,000,000
	Current Est. Complete Date:	June 21, 2020	Current Contract Value (with this action): \$41,000,000
7.	Contract Administrator: Mark T. Penn		Telephone Number: 213.922.1455
8.	Project Manager: Androush Danielians		Telephone Number: 213.922.7598

A. Procurement Background

This Board Action is to approve Contract Modification No. 1 to the On-Call Highway Program Project Delivery Support Services contracts issued in support of the I-210 Barrier Replacement Program.

This Contract Modification will be processed in accordance with Metro's Acquisition Policy and the contract type is a task order based firm fixed price.

On June 27, 2017, the Board awarded three contracts where work will be authorized through the issuance of separate FFP task orders. The Board approved cumulative total value of the three contracts combined is not-to-exceed \$30,000,000. The contracts were awarded to AECOM Technical Services Inc. (Contract No.

AE30673000), CH2M Hill Inc./Jacobs (Contract No. AE30673001), and Parsons Transportation Group, Inc. (Contract No. AE30673002). CH2M Hill Inc. was the prime contractor on the I-210 Barrier Replacement Program and has, to date, provided a 60% complete design drawing package on the project.

B. Cost Analysis

Work will be performed through the issuance of separate task orders. Proposals submitted for each task order will be subjected to audits, cost analysis, technical analysis, fact finding, and negotiations to determine the fairness and reasonableness of price.

(Refer to Attachment B – Contract Modification/Change Order Log)

CONTRACT MODIFICATION/CHANGE ORDER LOG

ON-CALL HIGHWAY PROGRAM PROJECT DELIVERY SUPPORT SERVICES

AE30673000/AE30673001/AE30673002

Mod. No.	Description	Status (approved or pending)	Date	\$ Amount
1	Replace existing I-210 non-standard barriers with taller barriers capable of withstanding crash loads equivalent to TL-5 load rated barriers.	Pending	03/28/19	\$11,000,000
	Modification Total:			\$11,000,000
	Original Contract(s):			\$30,000,000
	Total:			\$41,000,000

DEOD SUMMARY

I-210 Barrier Replacement/AE30673000/AE30673001/AE30673002

A. Small Business Participation

CH2M Hill Inc./Jacobs made a 27% SBE and 3% DVBE commitment. The project is 17% complete and CH2M Hill Inc./Jacobs current SBE/DVBE participation is 0%. CH2M Hill Inc./Jacobs has a current shortfall of 27% SBE and 3% DVBE. CH2M Hill Inc./Jacobs explained that their shortfall is due to only receiving three small task orders to date. CH2M Hill Inc./Jacobs projects that the task order currently being processed will increase their SBE/DVBE participation. The value of these task orders is approximately 3.5% of the total potential value of this overall contract, and CH2M Hill Inc./Jacobs indicated that they would be able to meet the SBE/DVBE commitment with future work. The value of these task orders is approximately 3.5% of the total potential value of this overall contract. CH2M Hill Inc./Jacobs has made a 36.31% SBE and 3.10% DVBE commitment on the pending modification which is projected to increase their SBE/DVBE participation. CH2M Hill Inc./Jacobs indicated that they will meet their SBE/DVBE commitment.

Notwithstanding, Metro Project Managers and Contract Administrators, will work in conjunction with DEOD to ensure that CH2M Hill Inc./Jacobs is on schedule to meet or exceed its DBE commitment. If CH2M Hill Inc./Jacobs is not on track to meet its small business commitment, Metro staff will ensure that CH2M Hill Inc./Jacobs submits an updated mitigation plan. Additionally, key stakeholders associated with the contract have been provided access to Metro’s tracking and monitoring system to ensure that all parties are actively tracking Small Business progress.

Small Business Commitment	27% SBE 3% DVBE	Small Business Participation	0% SBE 0% DVBE
----------------------------------	----------------------------	-------------------------------------	---------------------------

	SBE Subcontractors	% Committed	Current Participation¹
1.	ACT Consulting Engineers, Inc.	TBD	0.00%
2.	AP Engineering & Testing, Inc.	TBD	0.00%
3.	Arrellano Associates, LLC	TBD	0.00%
4.	Epic Land Solutions, Inc.	TBD	0.00%
5.	Geo- Advantec, Inc.	TBD	0.00%
6.	Hout Construction Services, Inc.	TBD	0.00%
7.	Martini Drilling Corporation	TBD	0.00%
8.	Minagar & Associates, Inc.	TBD	0.00%
9.	Pac Rim Engineering, Inc.	TBD	0.00%
10.	Rincon Consultants, Inc.	TBD	0.00%
11.	System Metrics Group, Inc.	TBD	0.00%

12.	Tatsumi & Partners, Inc.	TBD	0.00%
13.	Wagner Engineering & Surveying, Inc.	TBD	0.00%
	Total	27.00%	0.00%

	DVBE Subcontractors	% Committed	Current Participation¹
1.	Virtek Company	3.00%	0.00%
	Total	3.00%	0.00%

¹Current Participation = Total Actual amount Paid-to-Date to DBE firms ÷ Total Actual Amount Paid-to-date to Prime.

B. Living Wage and Service Contract Worker Retention Policy Applicability

The Living Wage and Service Contract Worker Retention Policy is not applicable to this

C. Prevailing Wage Applicability

Prevailing Wage requirements are applicable to this project. DEOD will monitor contractors' compliance with the State of California Department of Industrial Relations (DIR), California Labor Code, and, if federally funded, the U S Department of Labor (DOL) Davis Bacon and Related Acts (DBRA). Trades that may be covered include: surveying, potholing, field, soils and materials testing, building construction inspection, construction management and other support trades.

D. Project Labor Agreement/Construction Careers Policy

Project Labor Agreement/Construction Careers Policy is not applicable to this Contract. Project Labor Agreement/Construction Careers Policy is applicable only to construction contracts that have a construction contract value in excess of \$2.5 million.

FUNDING/EXPENDITURE PLAN

Project 405581 – Metro Gold Line Interstate 210 Median Barrier Replacement

Use of Funds	Expended Through FY18	FY19	FY20	Total	Total
Professional Services:					
Final Design Consultant	\$ 4,503,600	\$ 6,676,000	\$ 5,088,700	\$ 16,268,300	72%
Reviews/Coordination (Caltrans)	\$ 962,000	\$ 700,000	\$ 1,030,500	\$ 2,692,500	12%
CMA	\$ -	\$ 700,000	\$ 456,000	\$ 1,156,000	5%
Total Professional Services	\$ 5,465,600	\$ 8,076,000	\$ 6,575,200	\$ 20,116,800	89%
Metro Engineering & Administration	\$ 379,300	\$ 400,000	\$ 670,392	\$ 1,449,692	6%
Contingency	\$ -	\$ 600,000	\$ 450,900	\$ 1,050,900	5%
Total Project Cost	\$ 5,844,900	\$ 9,076,000	\$ 7,696,492	\$ 22,617,392	100%
Sources of Funds	Funded Through FY18	FY19	FY20	Total	Total
Prop C 25%	\$ 5,844,900	\$ 9,076,000	\$ 7,696,492	\$ 22,617,392	100%
Total Project Funding	\$ 5,844,900	\$ 9,076,000	\$ 7,696,492	\$ 22,617,392	100%

Los Angeles County Metropolitan Transportation Authority



Gold Line I-210 Barrier Replacement Project

March 28, 2019 Board Presentation



Gold Line I-210 Barrier Replacement - Project Limits



Split into 2 Projects for Expediency

Total Project: Marengo Tunnel to Iconic Bridge

Project 1: Michillinda Avenue to Iconic Bridge

Project 2: Marengo Tunnel to Michillinda Ave.

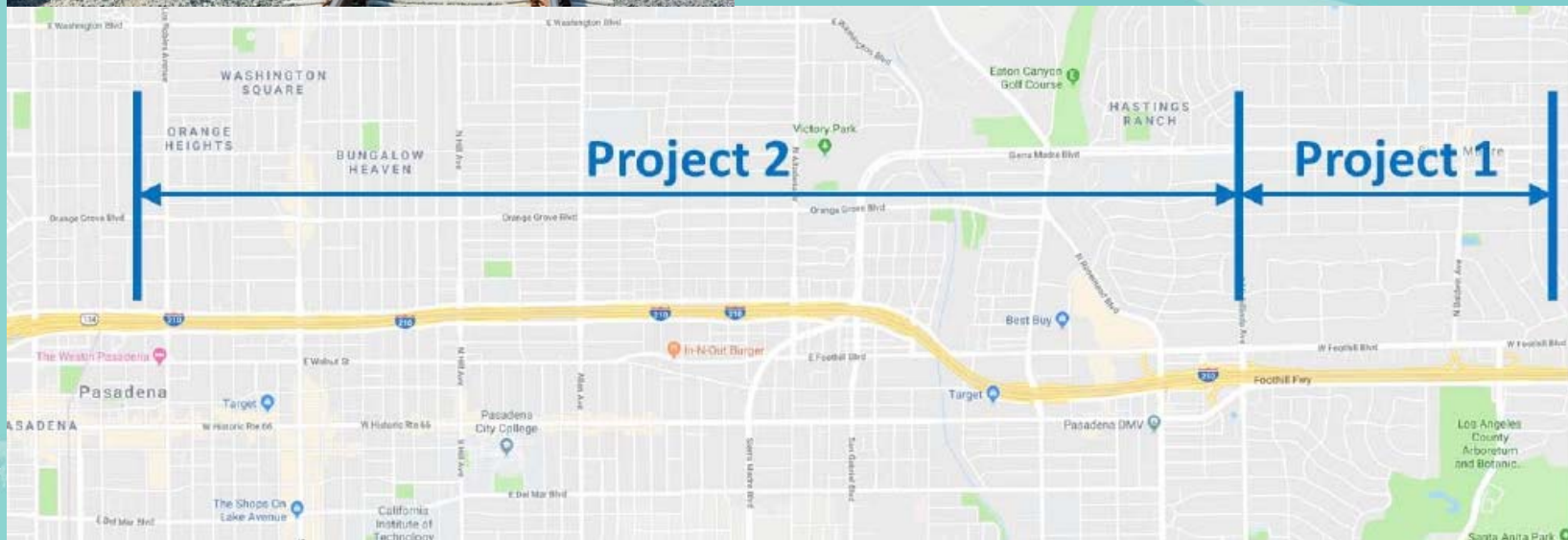

Gold Line I-210 Barrier Replacement - A Safety Project



Metro Gold Line: I-210 Median Vehicle Breach Incident Map:

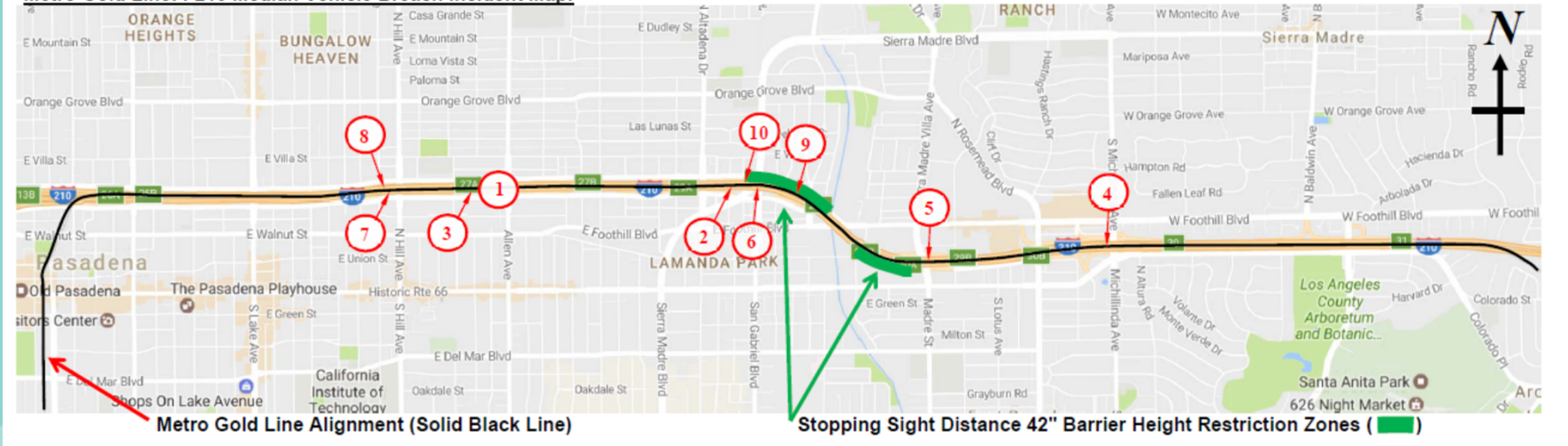

Gold Line I-210 barriers are being replaced to prevent this from occurring in the future.



Gold Line I-210 Barrier Replacement – Existing and Proposed Barrier Configurations

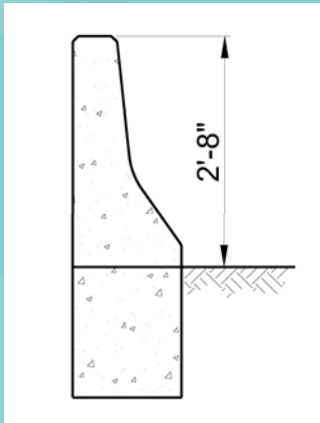

On Ground

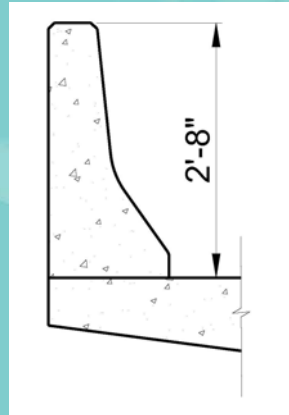

On Bridge

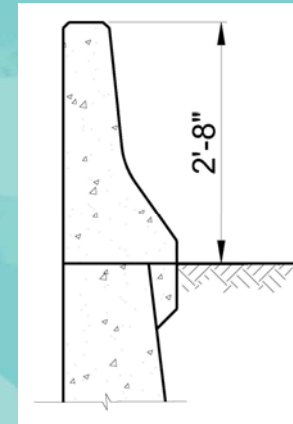

On Retaining Wall

Existing Barrier Configurations

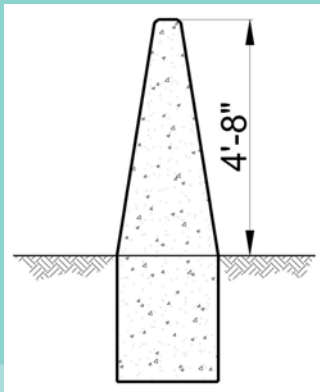

On Ground

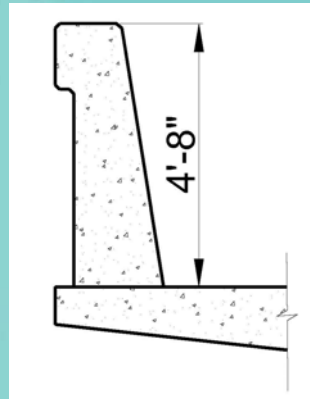

On Bridge

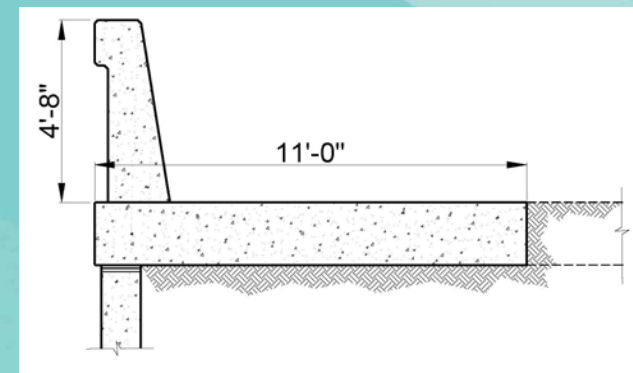

On Retaining Wall



Metro

Proposed Barrier Configurations

Gold Line I-210 Barrier Replacement – Addressing the Challenges

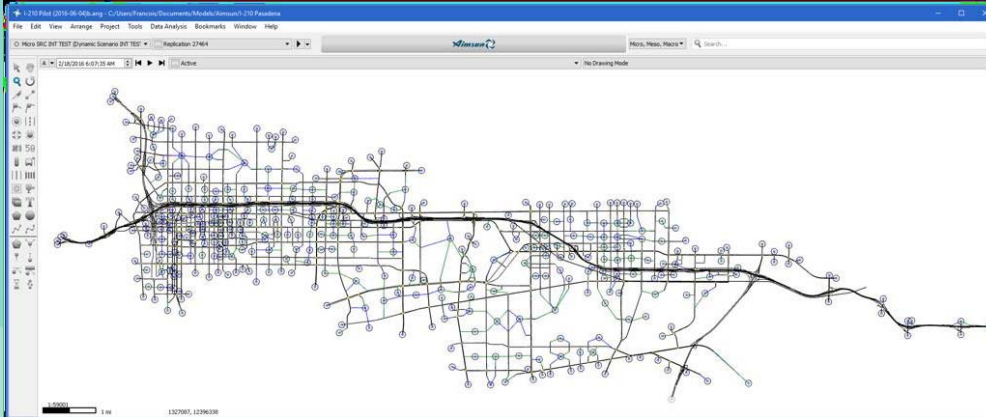

Optimized Solutions:

- Extremely tight workspace causing HOV lane closure and single tracking for the construction of Project 2; complicating environmental clearance
- Complex traffic study underway to quantify traffic impacts to the freeway and city streets



Thank you

